

# Bookmark Modular Circulation Desks

## HPL Bookmark Circulation Desks - General Specifications

**Modular Case System:** Each case module is fully assembled, allowing for simple field assembly of the complete circulation desk as well as for easy reconfiguration, if necessary. Cases connect with male/female threaded metal connectors.

**Top:** Tops are 1-1/4" thick, three ply engineered wood construction with .050"High pressure laminate, HPL, and a phenolic backer sheet. All edges and back side of the top are edged with 3mm PVC.

\*\*Transaction tops are integrated into desk units.

\*\* Grommets are included standard on Desk Modules.

**Case Construction:** Circulation desk modules are constructed of 3/4" thick, three ply particleboard with vertical grade HPL on both faces. All modules utilize a continuous front design (sides do not penetrate), with a 4"High recessed toe. Cabinets are assembled using glue and dowel joinery. Note: One Terminating End Panel is required for each exposed end of a complete desk assembly. Terminating end panels are available to create right or left facing units. Right side and left side is determined from the perspective of the desk user.

**Adjustable Shelves:** Adjustable shelves are 3/4" thick three ply particleboard plywood with vertical grade HPL on both faces. The exposed edges are edged 3mm PVC. Shelves are adjustable on 32mm increments.

**Drawers:** Drawers are constructed of 3/4" thick maple TFL with PVC edges. Drawers have 3/4" thick fronts with HPL faces and 3mm PVC edges. Box drawers have 100 lb. full extension slides, file drawers have 100 lb. full extension slides.

**Doors:** Doors are constructed of 3/4" thick, three ply particleboard with HPL faces and edged on all sides with 3mm PVC. Door hardware includes concealed hinges, fully adjustable in all 3 axes, and wire pulls.

\* Doors and Drawers are non-locking.

## Veneer Bookmark Circulation Desks - General Specifications

**Modular Case System:** Each case module is fully assembled, allowing for simple field assembly of the complete circulation desk as well as for easy reconfiguration, if necessary. Cases connect with male/female threaded metal connectors.

**Top:** Tops are 1-1/4" thick, three ply engineered wood construction with .050"High pressure laminate, HPL, and a phenolic backer sheet. The patron side is edged with 5/16" x 1-1/4" solid red oak with a 1/4" radius top and bottom. The edges and back side of the top are edged with 1/8" solid red oak.

\*\*Transaction tops are integrated into desk units.

\*\* Grommets are included standard on Desk Modules.

**Case Construction:** Circulation desk modules are constructed of 3/4" thick, three ply particleboard with plain sliced "A" grade oak veneer. All modules utilize a continuous front design (sides do not penetrate), with a 4"High recessed toe. Cabinets are assembled using glue and dowel joinery. Note: One Terminating End Panel is required for each exposed end of a complete desk assembly. Terminating end panels are available to create right or left facing units. Right side and left side is determined from the perspective of the desk user.

**Adjustable Shelves:** Adjustable shelves are 3/4" thick three ply particleboard plywood with "A" grade oak veneer faces. The exposed edges are edged with 1/8" solid red oak. Shelves are adjustable on 32mm increments.

**Drawers:** Drawers are constructed of 3/4" thick veneer plywood with a natural finish. Drawers have 3/4" thick fronts with "A" grade oak veneer. Box drawers have 100 lb. full extension slides, file drawers have 100 lb. full extension slides.

**Doors:** Doors are constructed of 3/4" thick, three ply particleboard with plain sliced "A" grade oak veneer faces and edged on all sides with 1/8" solid red oak. Door hardware includes concealed hinges, fully adjustable in all 3 axes, and wire pulls.

\* Doors and Drawers are non-locking.

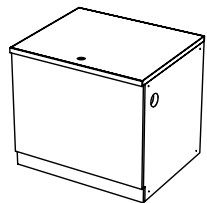

**Bookmark:** no detail.

Model Number example for  
HPL Bookmark Desk unit;  
MCD-36D-29**L**

Veneer Bookmark Desk unit;  
MCD-36D-29

**L = HPL**

**M = Maple Veneer**

**Model # example for HPL Bookmark 36" Wide Desk Unit with integrated Transaction Top**

**MCD - 36D - 32/TRX39L**

Modular Circulation Desk	36 W" Desk	Worksurface H"	Transaction H"	HPL

**Model # example for Veneer Bookmark 36" Wide Desk Unit with integrated Transaction Top**

**MCD - 36D - 32/TRX39**

Modular Circulation Desk	36 W" Desk	Worksurface H"	Transaction H"

# Modular Circulation Desks

**Design Lines:** mediatechnologies® offers 4 design lines of circulation desk modules, all using the general construction specifications of Bookmark Circulation Desks.

To specify a design line you must include a letter indicator: No letter indicator will specify our standard Bookmark design.

**M**-Metro    **L**-Lexington    **H**-Heritage    **CL**-Charleston

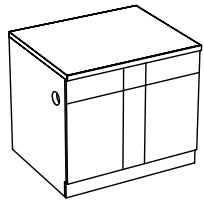

## Metro

Model Number example for HPL Metro Desk unit; MCD-M-36D-29

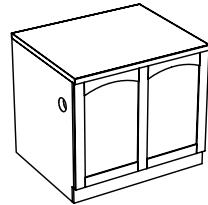

## Lexington

Model Number example for HPL Metro Desk unit; MCD-L-36D-29

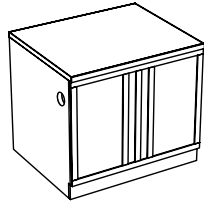

## Heritage

Model Number example for HPL Metro Desk unit; MCD-H-36D-29

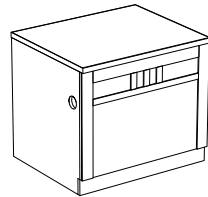

## Charleston

Model Number example for HPL Metro Desk unit; MCD-CL-36D-29

### Grommets are standard on desk units:

Desk Units 60" Wide and under receive (1) Grommet centered

72"W Desk Units receive (2) Grommets

\*Additional Grommets may be specified.

\*\* APA Desks DO NOT get grommets

GROMMETS		
Model Number	Description	List Price
A25GD	Grommet, Round, 50mm, Black, Installed, used for vertical applications	\$48
A25GD-W	Grommet, Round, 50mm, White, Installed, used for vertical applications	\$48
A25GDU	Grommet, Round, 50mm, Black, Uninstalled, used for vertical applications	\$18
A25GDU-W	Grommet, Round, 50mm, White, Uninstalled, used for vertical applications	\$18
A20G	Grommet, Round, 50mm, Black, Installed	\$47
A20GU	Grommet, Round, 50mm, Black, Uninstalled	\$16
A30G	Grommet, Round, 80mm, Black, Installed	\$47
A30GU	Grommet, Round, 80mm, Black, Uninstalled	\$16

Prices and specifications subject to change without notice

### Transaction Top Integration:

Transaction tops are integrated into each desk unit.

Desk Module + Trans Top = Desk module/TRX39  
example MCD-36D-32/TRX39L

Base Model  
Bookmark 36"W Desk

Transaction  
H"

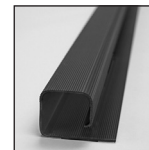

### Cable Channel:

Cable wire management channels come standard on each desk unit and are cut to fit. They are a PVC material.

# Bookmark Modular Circulation Desks

## Kneespace Panel Option:

Desk units can be specified with a kneespace panel on left or right, or both sides of the unit to allow for ease of leg movement between modules.

## MCD-36D-KSR-32/TRX39

Modular Circulation Desk  
 Module W" Desk Unit  
 Worksurface H" Transaction H"  
 Kneespace Panel Right

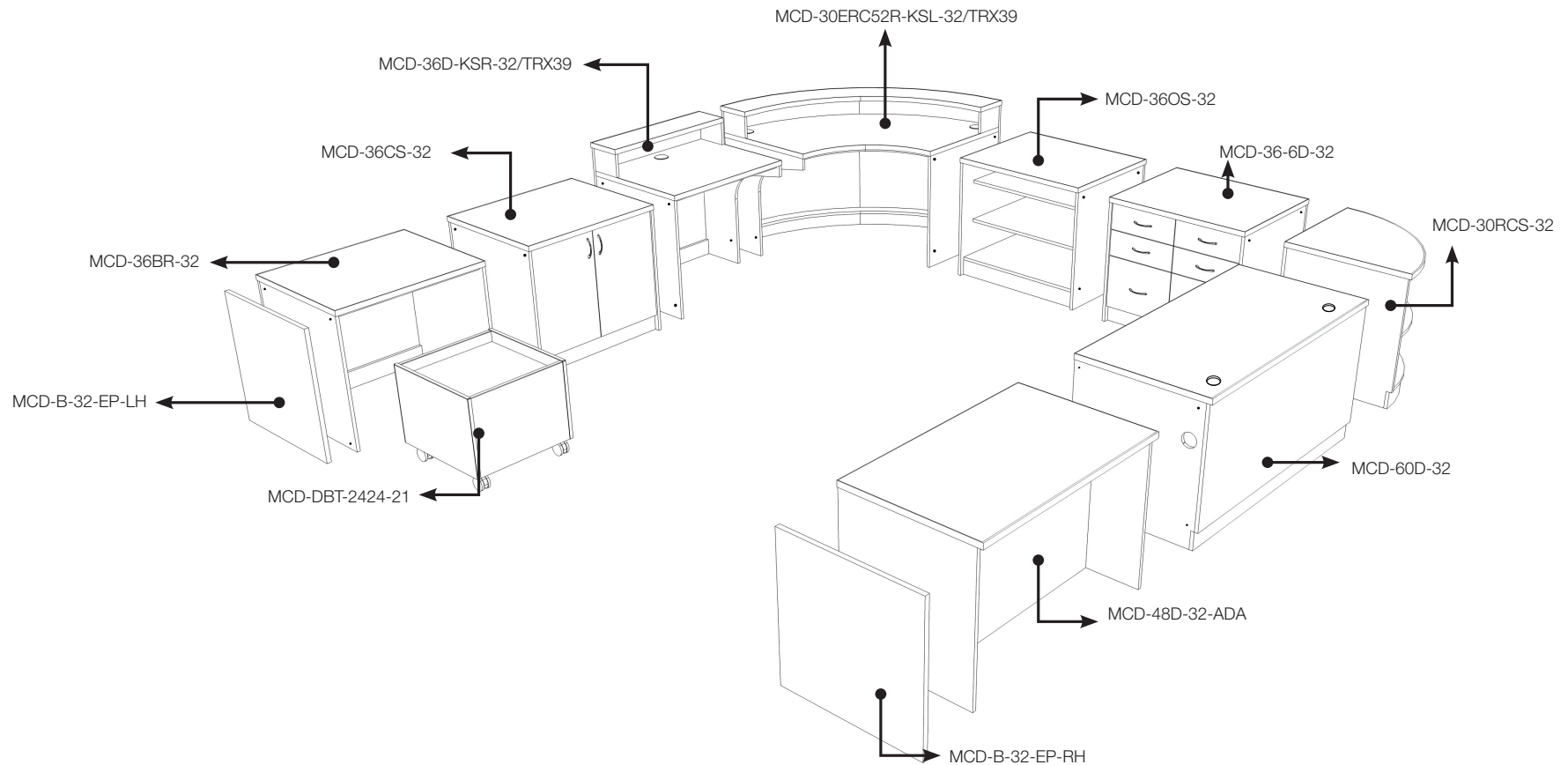
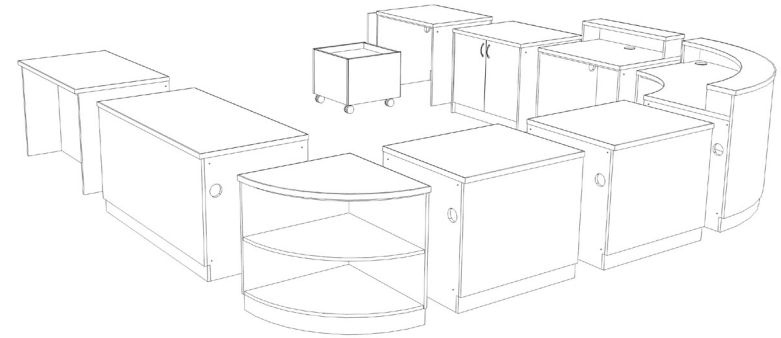
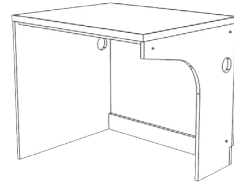

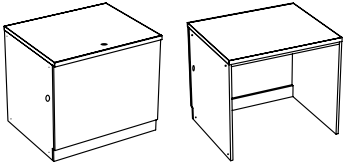
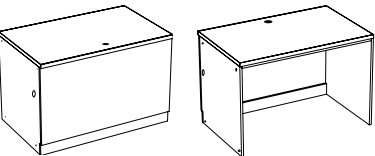
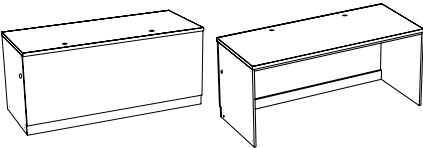
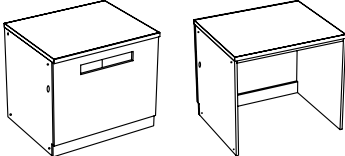
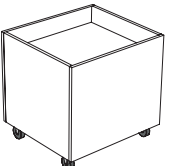

# Bookmark Modular Circulation Desks

Desk Units		Model Number	Description	Wgt.	Price
<b>36" Wide</b> 		MCD-36D-29L	Desk Unit, 36"W X 30"D X 29" H	116	\$2,429
		MCD-36D-32L	Desk Unit, 36"W X 30"D X 32" H	122	\$2,429
		MCD-36D-32L-ADA	ADA Desk Unit, 36"W X 30"D X 32"H	122	\$2,429
		MCD-36D-39L	Desk Unit, 36"W X 30"D X 39" H	137	\$2,583
<b>48" Wide</b> 		MCD-48D-29L	Desk Unit, 48"W X 30"D X 29" H	127	\$3,233
		MCD-48D-32L	Desk Unit, 48"W X 30"D X 32" H	134	\$3,233
		MCD-48D-39L	Desk Unit, 48"W X 30"D X 39" H	149	\$3,428
<b>72" Wide</b> 		MCD-72D-29L	Desk Unit, 72"W X 30"D X 29" H	201	\$4,932
		MCD-72D-32L	Desk Unit, 72"W X 30"D X 32" H	208	\$4,932
		MCD-72D-39L	Desk Unit, 72"W X 30"D X 39" H	226	\$4,955
<p>Note: Desk units are available in other lengths to meet specific project needs. Please inquire.</p>					
<b>Book Return Module</b> 		MCD-36BR-29L	Book Return, 36"W X 30"D X 29" H	115	\$2,600
		MCD-36BR-32L	Book Return, 36"W X 30"D X 32" H	121	\$2,600
		MCD-36BR-39L	Book Return, 36"W X 30"D X 39" H	136	\$2,758
<b>Descending Platform Book Truck</b> 		MCD-DBTL-1824-21	Depressible Platform Book Truck, 18"D x 24.25"W x 21"H, For curved 29"H Book Return Units and Nomad Book Return	135	\$2,950
		MCD-DBTL-1824-24	Depressible Platform Book Truck, 18"D x 24.25"W x 24"H, For Curved 32"-39"H Book Return Units	135	\$2,950
		MCD-DBTL-2424-21	Depressible Platform Book Truck, 23.625"D x 24.25"W x 21"H, For 29"H Book Return Units with Extended Chutes and 32"H Keystone and Malibu Book Returns	137	\$2,950
		MCD-DBTL-2424-24	Depressible Platform Book Truck, 23.625"D x 24.25"W x 24"H, For 32" and #("H Book Return Units	137	\$2,950

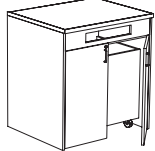
# Bookmark Modular Circulation Desks

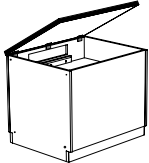
Stand-Alone Book Return and Descending Book Truck	Model Number	Description	Wgt.	List Price
	MCD-36CBRL/DBTL-2424-24	Book Return, 36"W X 30"D X 48" H and Book Truck 24" D X 24" W X 24"	252	\$6,218

Front Panel Slot Book Return Module with Descending Platform	Model Number	Description	Wgt.	List Price
	MCD-S36BR-32L	Book Return w Front Panel Slot & Descending Platform, 36"W X 30"D X 32" H	195	\$3,588
	MCD-S36BR-39L	Book Return w Front Panel Slot & Descending Platform, 36"W X 30"D X 39" H	210	\$3,805

Top Surface Slot Book Return Module with Drawer and Shelf Storage	Model Number	Description	Wgt.	List Price
	MCD-36SBR-TOP-29L	Book Return w Top Slot, 36"W X 30"D X 29" H	198	\$3,769
	MCD-36SBR-TOP-32L	Book Return w Top Slot, 36"W X 30"D X 32" H	201	\$3,769
	MCD-36SBR-TOP-39L	Book Return w Top Slot, 36"W X 30"D X 39" H	215	\$3,804

Drawer Units	Model Number	Description	Wgt.	List Price
	MCD-36-4D-29L	Drawer Unit, 36"W X 30"D X 29" H with 4 drawers	240	\$6,232
	MCD-36-4D-32L	Drawer Unit, 36"W X 30"D X 32" H with 4 drawers	245	\$6,322
	MCD-36-6D-32L	Drawer Unit, 36"W X 30"D X 32" H with 6 drawers	250	\$6,455
	MCD-36-6D-39L	Drawer Unit, 36"W X 30"D X 39" H with 6 drawers	284	\$6,519

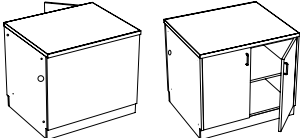
Cupboard Units	Model Number	Description	Wgt.	List Price
	MCD-36CS-29L	Cupboard Unit, 36"W X 30"D X 29" H	187	\$3,683
	MCD-36CS-32L	Cupboard Unit, 36"W X 30"D X 32" H	190	\$3,683
	MCD-36CS-39L	Cupboard Unit, 36"W X 30"D X 39" H	208	\$3,722

# Bookmark Modular Circulation Desks

## Cupboard Unit With Drawer

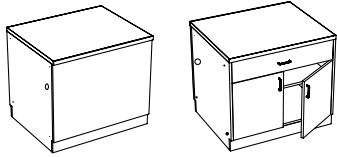

Model Number	Description	Wgt.	List Price
MCD-36CD-29L	Cupboard Unit, 36"W X 30"D X 29" H with drawer	199	\$4,238
MCD-36CD-32L	Cupboard Unit, 36"W X 30"D X 32" H with drawer	205	\$4,238
MCD-36CD-39L	Cupboard Unit, 36"W X 30"D X 39" H with drawer	223	\$4,270

## Cupboard Unit With 2 & 3 Drawers (Cupboard Left)

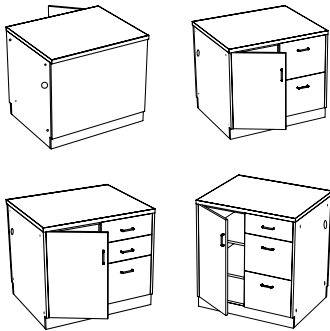

Model Number	Description	Wgt.	List Price
MCD-36C2DL-29L	Cupboard Unit, Left, 36"W X 30"D X 29" H with 2 drawers, file/file	220	\$5,402
MCD-36C2DL-32L	Cupboard Unit, Left, 36"W X 30"D X 32" H with 2 drawers, file/file	223	\$5,402
MCD-36C3DL-32L	Cupboard Unit, Left, 36"W X 30"D X 32" H with 3 drawers, box/box/file	228	\$5,617
MCD-36C3DL-39L	Cupboard Unit, Left, 36"W X 30"D X 39" H with 3 drawers, box/file/file	254	\$5,667

Drawers in these units accommodate standard hanging files.

## Cupboard Unit With 2 & 3 Drawers (Cupboard Right)

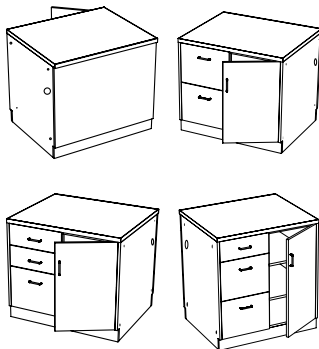

Model Number	Description	Wgt.	List Price
MCD-36C2DR-29L	Cupboard Unit, Right, 36"W X 30"D X 29" H with 2 drawers, file/file	220	\$5,402
MCD-36C2DR-32L	Cupboard Unit, Right, 36"W X 30"D X 32" H with 2 drawers, file/file	223	\$5,402
MCD-36C3DR-32L	Cupboard Unit, Right, 36"W X 30"D X 32" H with 3 drawers, box/box/file	228	\$5,617
MCD-36C3DR-39L	Cupboard Unit, Right, 36"W X 30"D X 39" H with 3 drawers, box/file/file	254	\$5,667

Drawers in these units accommodate standard hanging files.

# Bookmark Modular Circulation Desks

## Cupboard Unit With Open Storage (Cupboard Left)

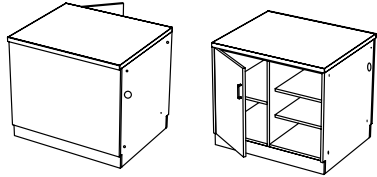

Model Number	Description	Wgt.	List Price
MCD-36COSL-29L	Cupboard Unit, Left, 36"W X 30"D X 29" H with open storage	184	\$3,861
MCD-36COSL-32L	Cupboard Unit, Left, 36"W X 30"D X 32" H with open storage	188	\$3,861
MCD-36COSL-39L	Cupboard Unit, Left, 36"W X 30"D X 39" H with open storage	202	\$3,912

## Cupboard Unit With Open Storage (Cupboard Right)

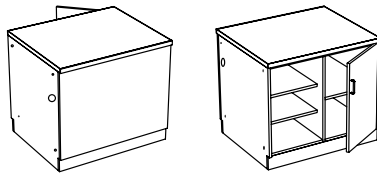

Model Number	Description	Wgt.	List Price
MCD-36COSR-29L	Cupboard Unit, Right, 36"W X 30"D X 29" H with open storage	184	\$3,861
MCD-36COSR-32L	Cupboard Unit, Right, 36"W X 30"D X 32" H with open storage	188	\$3,861
MCD-36COSR-39L	Cupboard Unit, Right, 36"W X 30"D X 39" H with open storage	202	\$3,912

## Open Storage Units

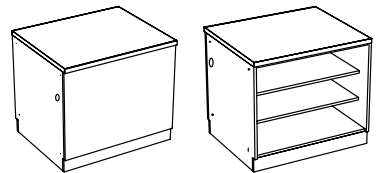

Model Number	Description	Wgt.	List Price
MCD-36OS-29L	Open Storage, 36"W X 30"D X 29" H	183	\$2,956
MCD-36OS-32L	Open Storage, 36"W X 30"D X 32" H	186	\$2,956
MCD-36OS-39L	Open Storage, 36"W X 30"D X 39" H	200	\$2,986

## Open Storage Unit With Drawer

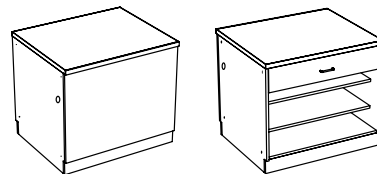

Model Number	Description	Wgt.	List Price
MCD-36OSD-29L	Open Storage, 36"W X 30"D X 29" H with drawer	198	\$3,629
MCD-36OSD-32L	Open Storage, 36"W X 30"D X 32" H with drawer	201	\$3,629
MCD-36OSD-39L	Open Storage, 36"W X 30"D X 39" H with drawer	215	\$3,661

# Bookmark Modular Circulation Desks

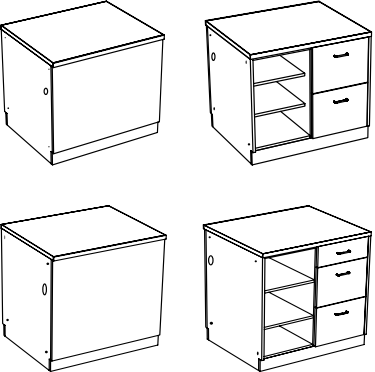
Open Storage Unit With 2 & 3 Drawers (Open Storage Left)	Model Number	Description	Wgt.	List Price
	MCD-360S2DL-29L	Open Storage, Left, 36"W X 30"D X 29" H with 2 drawers, file/file	207	\$5,274
	MCD-360S2DL-32L	Open Storage, Left, 36"W X 30"D X 32" H with 2 drawers, file/file	210	\$5,274
	MCD-360S3DL-32L	Open Storage, Left, 36"W X 30"D X 32" H with 3 drawers, box/box/file	218	\$5,456
	MCD-360S3DL-39L	Open Storage, Left, 36"W X 30"D X 39" H with 3 drawers, box/file/file	238	\$5,688

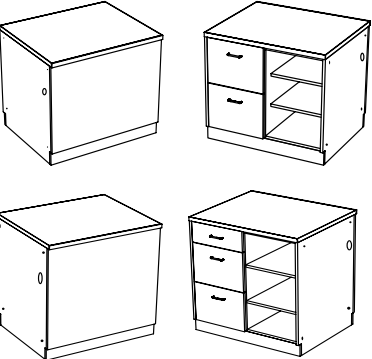
Open Storage Unit With 2 & 3 Drawers (Open Storage Right)	Model Number	Description	Wgt.	List Price
	MCD-360S2DR-29L	Open Storage, Right, 36"W X 30"D X 29" H with 2 drawers, file/file	207	\$5,274
	MCD-360S2DR-32L	Open Storage, Right, 36"W X 30"D X 32" H with 2 drawers, file/file	210	\$5,274
	MCD-360S3DR-32L	Open Storage, Right, 36"W X 30"D X 32" H with 3 drawers, box/box/file	218	\$5,456
	MCD-360S3DR-39L	Open Storage, Right, 36"W X 30"D X 39" H with 3 drawers, box/file/file	238	\$5,688

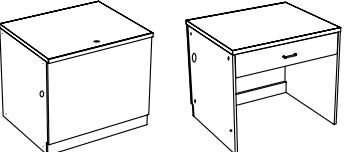
Kneespace Unit	Model Number	Description	Wgt.	List Price
	MCD-36KS-32L	Kneespace Unit, 36"W X 30"D X 32" H	136	\$3,412
	MCD-36KS-39L	Kneespace Unit, 36"W X 30"D X 39" H	149	\$3,446

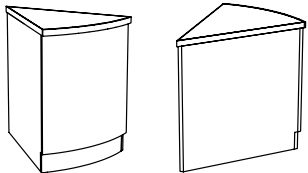
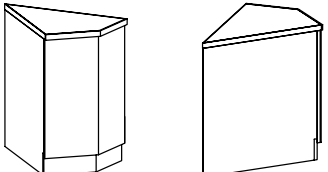
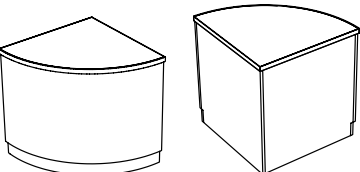
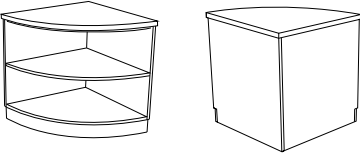
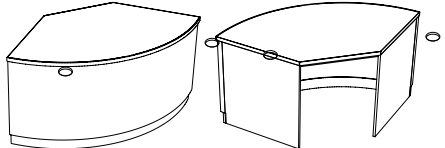

# Bookmark Modular Circulation Desks

Corner Units		Model Number	Description	Wgt.	List Price
		MCD-30RC45-29L	Radius Corner, 22"W X 30"D X 29" H	74	\$3,177
		MCD-30RC45-32L	Radius Corner, 22"W X 30"D X 32" H	77	\$3,177
		MCD-30RC45-39L	Radius Corner, 22"W X 30"D X 39" H	84	\$3,483
		MCD-30FC45-29L	Flat Corner, 22"W X 30"D X 29" H	74	\$3,177
		MCD-30FC45-32L	Flat Corner, 22"W X 30"D X 32" H	77	\$3,177
		MCD-30FC45-39L	Flat Corner, 22"W X 30"D X 39" H	84	\$3,483
		MCD-30RC-29L	Radius Corner, 30"W X 30"D X 29" H	148	\$3,311
		MCD-30RC-32L	Radius Corner, 30"W X 30"D X 32" H	153	\$3,311
		MCD-30RC-39L	Radius Corner, 30"W X 30"D X 39" H	168	\$3,483
		MCD-30RCS-29L	Open Radius Corner with Shelves, 30"W X 30"D X 29" H		\$2,857
		MCD-30RCS-32L	Open Radius Corner with Shelves, 30"W X 30"D X 32" H		\$3,008
		MCD-30RCS-39L	Open Radius Corner with Shelves, 30"W X 30"D X 39" H		\$3,015
		MCD-30ERC-29L	Radius Ext. Corner, 66"W X 30"D X 29" H	276	\$6,903
		MCD-30ERC-32L	Radius Ext. Corner, 66"W X 30"D X 32" H	284	\$6,903
		MCD-30ERC-39L	Radius Ext. Corner, 66"W X 30"D X 39" H	306	\$7,096

# Bookmark Modular Circulation Desks

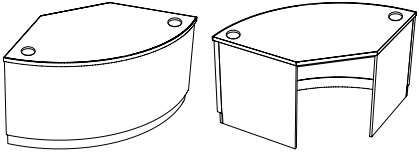
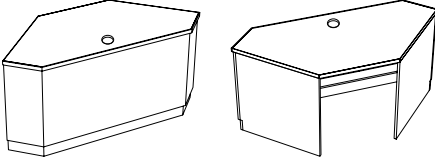
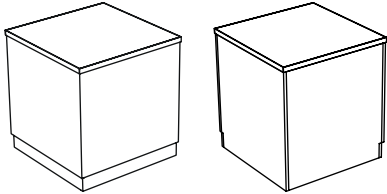
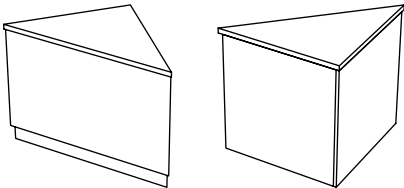
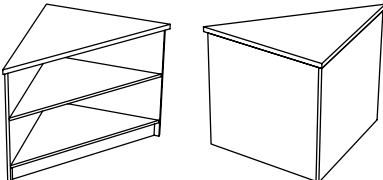
90 Degree Extended 52" Radius	Model Number	Description	Wgt.	List Price
	MCD-30ERC52R-29L	Radius Ext. Corner, 74"W X 30"D X 29" H		\$8,820
	MCD-30ERC52R-32L	Radius Ext. Corner, 74"W X 30"D X 32" H		\$8,820
	MCD-30ERC52R-39L	Radius Ext. Corner, 74"W X 30"D X 39" H		\$9,003
90 Degree Extended Flat	Model Number	Description	Wgt.	List Price
	MCD-30EFC-29L	Flat Ext. Corner, 66"W X 30"D X 29" H	164	\$5,869
	MCD-30EFC-32L	Flat Ext. Corner, 66"W X 30"D X 32" H	173	\$5,869
	MCD-30EFC-39L	Flat Ext. Corner, 66"W X 30"D X 39" H	190	\$6,035
90 Degree Square	Model Number	Description	Wgt.	List Price
	MCD-30SC-29L	Square Corner, 30"W X 30"D X 29"H	150	\$2,720
	MCD-30SC-32L	Square Corner, 30"W X 30"D X 32"H	155	\$2,720
	MCD-30SC-39L	Square Corner, 30"W X 30"D X 39"H	170	\$2,864
Triangle Corner Unit	Model Number	Description	Wgt.	List Price
	MCD-30TC-29L	Triangle Corner, 30"W X 30"D X 29" H	87	\$2,720
	MCD-30TC-32L	Triangle Corner, 30"W X 30"D X 32" H	89	\$2,720
	MCD-30TC-39L	Triangle Corner, 30"W X 30"D X 39" H	97	\$2,866
Triangle Corner Unit with Shelves	Model Number	Description	Wgt.	List Price
	MCD-30TCS-29L	Triangle Corner, 30"W X 30"D X 29" H with shelves	85	\$2,950
	MCD-30TCS-32L	Triangle Corner, 30"W X 30"D X 32" H with shelves	87	\$2,950
	MCD-30TCS-39L	Triangle Corner, 30"W X 30"D X 39" H with shelves	95	\$3,105

# Bookmark Modular Circulation Desks

Double Action Gate	Model Number	Description	Wgt.	List Price
	MCD-GATE-32L	Double Action Gate for 32"H Modules, 36"W x 1"D x 26"H	24	\$891
	MCD-GATE-39L	Double Action Gate for 39"H Modules, 36"W x 1"D x 33"H	28	\$934

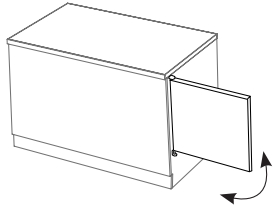

Double action gate swings both ways.

Note: Application of gate requires terminating end panel.

## Circulation Desk End Panels

Note: One Terminating End Panel is required for each exposed end of a complete desk assembly. End Panels are available in all standard design lines. Terminating end panels are available to create right or left facing units. Right side and left side is determined from the perspective of the desk user.

Bookmark	Model Number	Description	Wgt.	Price
	MCD-B-29-EPL-LH	Bookmark Finished End Panel for 29"H Unit, Left hand	18	\$683
	MCD-B-29-EPL-RH	Bookmark Finished End Panel for 29"H Unit, Right hand	18	\$683
	MCD-B-32-EPL-LH	Bookmark Finished End Panel for 32"H Unit, Left hand	19	\$683
	MCD-B-32-EPL-RH	Bookmark Finished End Panel for 32"H Unit, Right hand	19	\$683
	MCD-B-39-EPL-LH	Bookmark Finished End Panel for 39"H Unit, Left hand	23	\$790
	MCD-B-39-EPL-RH	Bookmark Finished End Panel for 39"H Unit, Right hand	23	\$790

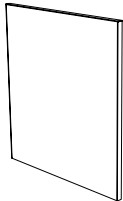

Set Up Charges and Upcharges for Non-Standard and Custom Finishes		
Model Number	Description	List Price
Non-Standard PVC	Upcharge, per color, per order, for non-standard PVC	\$911
Non-Standard HPL	Upcharge for nonstandard HPL (applies to Bella and Romak only)	\$690

## Transaction Tops

Desk Module + Trans Top = Desk module/TRX39  
 example MCD-36D-32/TRX39L

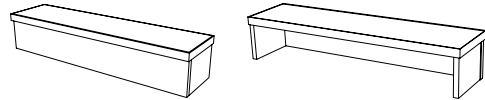

36" Transaction Tops	Model Number	Description	Wgt.	Price
	MCD-36-TRXL	Bookmark Transaction Top 36"W X 7"H	18	\$715
				745

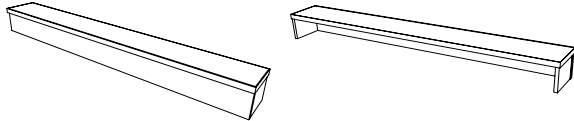

72" Transaction Tops	Model Number	Description	Wgt.	List Price
	MCD-72-TRXL	Bookmark Transaction Top 72"W X 7"H	32	\$1,422

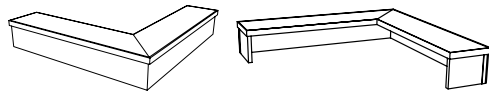

Square Corner Transaction Tops	Model Number	Description	Wgt.	List Price
	MCD-30SC-TRXL	Bookmark Transaction Top 9"D X 7"H	18	\$1,771

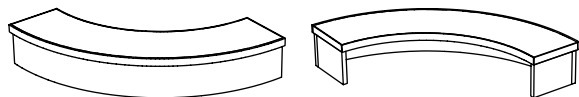

90° Radius Corner Transaction Top	Model Number	Description	Wgt.	List Price
	MCD-30RC-TRXL	Bookmark Transaction Top 9"D X 7"H	16	\$1,771

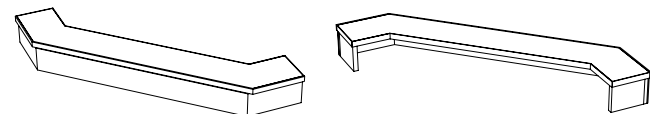

Extended Flat Corner	Model Number	Description	Wgt.	List Price
	MCD-30EFC-TRXL	Bookmark Transaction Top 9"D X 7"H	29	\$2,089

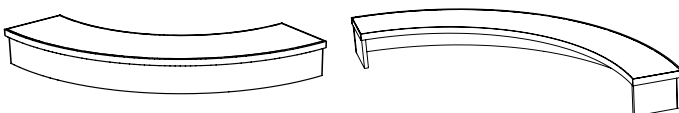

Extended Radius Corner	Model Number	Description	Wgt.	List Price
	MCD-30ERC-TRXL	Bookmark Transaction Top 9"D X 7"H	25	\$2,510