

# MILESTONE T-BASE

## Tables

### General Specifications

**Table Top:** Table tops are 1-1/4" thick, three-ply 45# particleboard construction with .050" high-pressure laminate top surface and a .030" phenolic backer. Square corners on banded tops have a 1/8" radius. Rounded corners on all tops have a 2" radius.

**Table Bases:** All table bases are supplied with 1" diameter leveling glides.

**T-Base - Single Column and Double Column:** 13 gauge, 2" diameter column and mainbar, 11 gauge stamped steel mounting plate, 10"x10"(or 12"x12" for single column bases with mainbars over 30"W).

**Folding base mechanism:** Nylon injection molded body with an extruded aluminum mechanism is bolted to leg frame via a threaded insert. Mechanism is attached to the underside of worksurface using a 1" #12 wood screws.

**Flip-top mechanism:** Two-part steel mechanism is joined via a pivot system. Upper component attaches to underside of worksurface using 1" #12 wood screws. Lower component bolts to leg frame via a threaded insert.

**Finishes:** Visit our website for Finish and Color Guide .

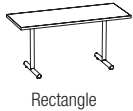

Rectangle



C 3MM PVC EDGES

**Required to order:** Model # including options if applicable

- HPL selection
- PVC selection (if applicable)
- wood edges finish (if applicable)
- powder coat selection

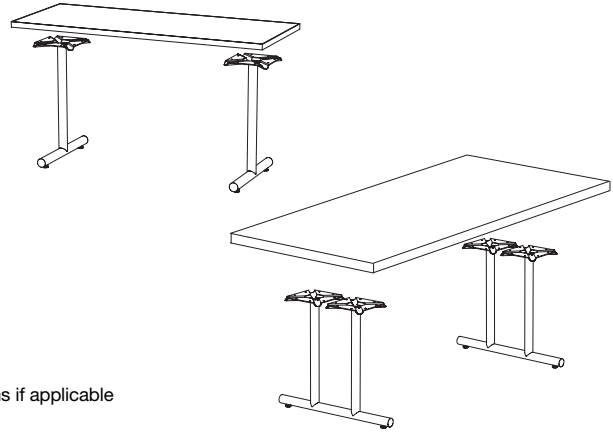

						Rectangular Tables						
Model Number	Description	Wt.	List Price	Model Number	Wt.	List Price	Model Number	Wt.	List Price	Model Number	Wt.	List Price
			3mm PVC Edges				3mm PVC Edges and 2 casters				3mm PVC Edges and 4 casters	3mm PVC Edges, Flip-top and 4 casters
MT22-C2436-29	24"W x 36"L x 29"H, (2) 22" T Bases	57	\$891	MT22-C2436-29-2C	58	\$935	MT22-C2436-29-4C	59	\$982	MT22-C2436-FT-29-4C	59	\$1,594
MT22-C2448-29	24"W x 48"L x 29"H, (2) 22" T Bases	69	\$956	MT22-C2448-29-2C	70	\$999	MT22-C2448-29-4C	71	\$1,046	MT22-C2448-FT-29-4C	71	\$1,658
MT22-C2460-29	24"W x 60"L x 29"H, (2) 22" T Bases	82	\$1,005	MT22-C2460-29-2C	83	\$1,048	MT22-C2460-29-4C	84	\$1,094	MT22-C2460-FT-29-4C	84	\$1,707
MT22-C2472-29	24"W x 72"L x 29"H, (2) 22" T Bases	94	\$1,102	MT22-C2472-29-2C	95	\$1,146	MT22-C2472-29-4C	96	\$1,192	MT22-C2472-FT-29-4C	96	\$1,882
MT22-C2484-29	24"W x 84"L x 29"H, (2) 22" T Bases	110	\$1,313	MT22-C2484-29-2C	111	\$1,357	MT22-C2484-29-4C	112	\$1,404	MT22-C2484-FT-29-4C	112	\$2,094
MT22-C2496-29	24"W x 96"L x 29"H, (2) 22" T Bases	118	\$1,313	MT22-C2496-29-2C	119	\$1,357	MT22-C2496-29-4C	120	\$1,404	MT22-C2496-FT-29-4C	120	\$2,094
MT22-C2436-36	24"W x 36"L x 36"H, (2) 22" T Bases	57	\$1,072	MT22-C2436-36-2C	58	\$1,116	MT22-C2436-36-4C	59	\$1,163	MT22-C2436-FT-36-4C	59	\$1,775
MT22-C2448-36	24"W x 48"L x 36"H, (2) 22" T Bases	69	\$1,137	MT22-C2448-36-2C	70	\$1,180	MT22-C2448-36-4C	71	\$1,227	MT22-C2448-FT-36-4C	71	\$1,839
MT22-C2460-36	24"W x 60"L x 36"H, (2) 22" T Bases	82	\$1,185	MT22-C2460-36-2C	83	\$1,229	MT22-C2460-36-4C	84	\$1,276	MT22-C2460-FT-36-4C	84	\$1,889
MT22-C2472-36	24"W x 72"L x 36"H, (2) 22" T Bases	94	\$1,283	MT22-C2472-36-2C	95	\$1,327	MT22-C2472-36-4C	96	\$1,373	MT22-C2472-FT-36-4C	96	\$2,063
MT22-C2484-36	24"W x 84"L x 36"H, (2) 22" T Bases	110	\$1,495	MT22-C2484-36-2C	111	\$1,539	MT22-C2484-36-4C	112	\$1,586	MT22-C2484-FT-36-4C	112	\$2,275
MT22-C2496-36	24"W x 96"L x 36"H, (2) 22" T Bases	118	\$1,495	MT22-C2496-36-2C	119	\$1,539	MT22-C2496-36-4C	120	\$1,586	MT22-C2496-FT-36-4C	120	\$2,275
MT22-C2436-42	24"W x 36"L x 42"H, (2) 22" T Bases	57	\$1,072	MT22-C2436-42-2C	58	\$1,116	MT22-C2436-42-4C	59	\$1,163	MT22-C2436-FT-42-4C	59	\$1,775
MT22-C2448-42	24"W x 48"L x 42"H, (2) 22" T Bases	69	\$1,137	MT22-C2448-42-2C	70	\$1,180	MT22-C2448-42-4C	71	\$1,227	MT22-C2448-FT-42-4C	71	\$1,839
MT22-C2460-42	24"W x 60"L x 42"H, (2) 22" T Bases	82	\$1,185	MT22-C2460-42-2C	83	\$1,229	MT22-C2460-42-4C	84	\$1,276	MT22-C2460-FT-42-4C	84	\$1,889
MT22-C2472-42	24"W x 72"L x 42"H, (2) 22" T Bases	94	\$1,283	MT22-C2472-42-2C	95	\$1,327	MT22-C2472-42-4C	96	\$1,373	MT22-C2472-FT-42-4C	96	\$2,063
MT22-C2484-42	24"W x 84"L x 42"H, (2) 22" T Bases	110	\$1,495	MT22-C2484-42-2C	111	\$1,539	MT22-C2484-42-4C	112	\$1,586	MT22-C2484-FT-42-4C	112	\$2,275
MT22-C2496-42	24"W x 96"L x 42"H, (2) 22" T Bases	118	\$1,495	MT22-C2496-42-2C	119	\$1,539	MT22-C2496-42-4C	120	\$1,586	MT22-C2496-FT-42-4C	120	\$2,275
MT26-C3036-29	30"W x 36"L x 29"H, (2) 26" T Bases	68	\$953	MT26-C3036-29-2C	69	\$996	MT26-C3036-29-4C	70	\$1,043	MT26-C3036-FT-29-4C	70	\$1,655
MT26-C3048-29	30"W x 48"L x 29"H, (2) 26" T Bases	83	\$1,031	MT26-C3048-29-2C	84	\$1,074	MT26-C3048-29-4C	85	\$1,122	MT26-C3048-FT-29-4C	85	\$1,733
MT26-C3060-29	30"W x 60"L x 29"H, (2) 26" T Bases	97	\$1,083	MT26-C3060-29-2C	98	\$1,126	MT26-C3060-29-4C	99	\$1,172	MT26-C3060-FT-29-4C	99	\$1,785
MT26-C3072-29	30"W x 72"L x 29"H, (2) 26" T Bases	112	\$1,154	MT26-C3072-29-2C	113	\$1,198	MT26-C3072-29-4C	114	\$1,245	MT26-C3072-FT-29-4C	114	\$1,935
MT26-C3084-29	30"W x 84"L x 29"H, (2) 26" T Bases	124	\$1,440	MT26-C3084-29-2C	125	\$1,485	MT26-C3084-29-4C	126	\$1,531	MT26-C3084-FT-29-4C	126	\$2,222
MT26-C3036-36	30"W x 36"L x 36"H, (2) 26" T Bases	68	\$1,134	MT26-C3036-36-2C	69	\$1,177	MT26-C3036-36-4C	70	\$1,224	MT26-C3036-FT-36-4C	70	\$1,836
MT26-C3048-36	30"W x 48"L x 36"H, (2) 26" T Bases	83	\$1,213	MT26-C3048-36-2C	84	\$1,256	MT26-C3048-36-4C	85	\$1,303	MT26-C3048-FT-36-4C	85	\$1,915
MT26-C3060-36	30"W x 60"L x 36"H, (2) 26" T Bases	97	\$1,263	MT26-C3060-36-2C	98	\$1,307	MT26-C3060-36-4C	99	\$1,353	MT26-C3060-FT-36-4C	99	\$1,966
MT26-C3072-36	30"W x 72"L x 36"H, (2) 26" T Bases	112	\$1,335	MT26-C3072-36-2C	113	\$1,379	MT26-C3072-36-4C	114	\$1,426	MT26-C3072-FT-36-4C	114	\$2,116
MT26-C3084-36	30"W x 84"L x 36"H, (2) 26" T Bases	124	\$1,622	MT26-C3084-36-2C	125	\$1,666	MT26-C3084-36-4C	126	\$1,711	MT26-C3084-FT-36-4C	126	\$2,403
MT26-C3036-42	30"W x 36"L x 42"H, (2) 26" T Bases	68	\$1,134	MT26-C3036-42-2C	69	\$1,177	MT26-C3036-42-4C	70	\$1,224	MT26-C3036-FT-42-4C	70	\$1,836
MT26-C3048-42	30"W x 48"L x 42"H, (2) 26" T Bases	83	\$1,213	MT26-C3048-42-2C	84	\$1,256	MT26-C3048-42-4C	85	\$1,303	MT26-C3048-FT-42-4C	85	\$1,915
MT26-C3060-42	30"W x 60"L x 42"H, (2) 26" T Bases	97	\$1,263	MT26-C3060-42-2C	98	\$1,307	MT26-C3060-42-4C	99	\$1,353	MT26-C3060-FT-42-4C	99	\$1,966
MT26-C3072-42	30"W x 72"L x 42"H, (2) 26" T Bases	112	\$1,335	MT26-C3072-42-2C	113	\$1,379	MT26-C3072-42-4C	114	\$1,426	MT26-C3072-FT-42-4C	114	\$2,116
MT26-C3084-42	30"W x 84"L x 42"H, (2) 26" T Bases	124	\$1,622	MT26-C3084-42-2C	125	\$1,666	MT26-C3084-42-4C	126	\$1,711	MT26-C3084-FT-42-4C	126	\$2,403
MT26-C3648-29	36"W x 48"L x 29"H, (2) 26" T Bases	83	\$1,064	MT26-C3648-29-2C	84	\$1,108	MT26-C3648-29-4C	85	\$1,153	MT26-C3648-FT-29-4C	85	\$1,767
MT26-C3660-29	36"W x 60"L x 29"H, (2) 26" T Bases	110	\$1,154	MT26-C3660-29-2C	111	\$1,198	MT26-C3660-29-4C	112	\$1,245	MT26-C3660-FT-29-4C	112	\$1,857
MT26-C3672-29	36"W x 72"L x 29"H, (2) 26" T Bases	127	\$1,183	MT26-C3672-29-2C	128	\$1,227	MT26-C3672-29-4C	129	\$1,273	MT26-C3672-FT-29-4C	129	\$1,964
MT26-C3684-29	36"W x 84"L x 29"H, (2) 26" T Bases	139	\$1,485	MT26-C3684-29-2C	140	\$1,529	MT26-C3684-29-4C	141	\$1,574	MT26-C3684-FT-29-4C	141	\$2,266
MT26-C3696-29	36"W x 96"L x 29"H, (2) 26" T Bases	144	\$1,491	MT26-C3696-29-2C	145	\$1,535	MT26-C3696-29-4C	146	\$1,583	MT26-C3696-FT-29-4C	146	\$2,272
MT26-C3648-36	36"W x 48"L x 36"H, (2) 26" T Bases	83	\$1,245	MT26-C3648-36-2C	84	\$1,288	MT26-C3648-36-4C	85	\$1,334	MT26-C3648-FT-36-4C	85	\$1,947
MT26-C3660-36	36"W x 60"L x 36"H, (2) 26" T Bases	110	\$1,335	MT26-C3660-36-2C	111	\$1,379	MT26-C3660-36-4C	112	\$1,426	MT26-C3660-FT-36-4C	112	\$2,038
MT26-C3672-36	36"W x 72"L x 36"H, (2) 26" T Bases	127	\$1,365	MT26-C3672-36-2C	128	\$1,409	MT26-C3672-36-4C	129	\$1,455	MT26-C3672-FT-36-4C	129	\$2,145
MT26-C3684-36	36"W x 84"L x 36"H, (2) 26" T Bases	139	\$1,666	MT26-C3684-36-2C	140	\$1,709	MT26-C3684-36-4C	141	\$1,755	MT26-C3684-FT-36-4C	141	\$2,446
MT26-C3696-36	36"W x 96"L x 36"H, (2) 26" T Bases	144	\$1,673	MT26-C3696-36-2C	145	\$1,717	MT26-C3696-36-4C	146	\$1,763	MT26-C3696-FT-36-4C	146	\$2,453
MT26-C3648-42	36"W x 48"L x 42"H, (2) 26" T Bases	83	\$1,245	MT26-C3648-42-2C	84	\$1,288	MT26-C3648-42-4C	85	\$1,334	MT26-C3648-FT-42-4C	85	\$1,947
MT26-C3660-42	36"W x 60"L x 42"H, (2) 26" T Bases	110	\$1,335	MT26-C3660-42-2C	111	\$1,379	MT26-C3660-42-4C	112	\$1,426	MT26-C3660-FT-42-4C	112	\$2,038
MT26-C3672-42	36"W x 72"L x 42"H, (2) 26" T Bases	127	\$1,365	MT26-C3672-42-2C	128	\$1,409	MT26-C3672-42-4C	129	\$1,455	MT26-C3672-FT-42-4C	129	\$2,145

Prices and specifications subject to change without notice

P-MILESTONE-240114

# RECTANGLE MILESTONE T-BASE

## Tables

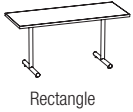

C 3MM PVC EDGES

**Required to order:** Model # including options if applicable

- HPL selection
- PVC selection (if applicable)
- wood edges finish (if applicable)
- powder coat selection

Rectangular Tables (cont.)												
Model Number	Description	Wt.	List Price	Model Number	Wt.	List Price	Model Number	Wt.	List Price	Model Number	Wt.	List Price
MT26-C3684-42	36"W x 84"L x 42"H, (2) 26" T Bases	139	\$1,666	MT26-C3684-42-2C	140	\$1,709	MT26-C3684-42-4C	141	\$1,755	MT26-C3684-FT-42-4C	141	\$2,446
MT26-C3696-42	36"W x 96"L x 42"H, (2) 26" T Bases	144	\$1,673	MT26-C3696-42-2C	145	\$1,717	MT26-C3696-42-4C	146	\$1,763	MT26-C3696-FT-42-4C	146	\$2,453
MTT36-C4860-29	48"W x 60"L x 29"H, (2) 36" TT Bases	142	\$1,573	MTT36-C4860-29-2C	143	\$1,617	MTT36-C4860-29-4C	144	\$1,664			
MTT36-C4872-29	48"W x 72"L x 29"H, (2) 36" TT Bases	162	\$1,695	MTT36-C4872-29-2C	163	\$1,739	MTT36-C4872-29-4C	164	\$1,785			
MTT36-C4884-29	48"W x 84"L x 29"H, (3) 36" TT Bases	182	\$1,865	MTT36-C6072-29-2C	214	\$2,488	MTT36-C6072-29-4C	215	\$2,534			
MTT36-C4896-29	48"W x 96"L x 29"H, (3) 36" TT Bases	201	\$1,869									
MTT36-C48120-29	48"W x 120"L x 29"H, (3) 36" TT Bases	263	\$2,650									
MTT36-C48144-29	48"W x 144"L x 29"H, (3) 36" TT Bases	302	\$2,879									
MTT36-C6072-29	60"W x 72"L x 29"H, (2) 36" TT Bases	213	\$2,444									
MTT36-C6096-29	60"W x 96"L x 29"H, (3) 36" TT Bases	275	\$2,837									
MTT36-C60120-29	60"W x 120"L x 29"H, (3) 36" TT Bases	371	\$4,063									
MTT36-C60144-29	60"W x 144"L x 29"H, (3) 36" TT Bases	434	\$4,600									

### Set Up Charges and Upcharges for Non-Standard and Custom Finishes

Model Number	Description	List Price
Group 2 Powder Coat	Set up charge, per color, per order, for Group 2 Powder Coat	\$329
Non-Standard PVC	Upcharge, per color, per order, for non-standard PVC	\$911
Custom Finish	Upcharge for custom stain finish	\$640
Non-Standard Stain	Upcharge for non-standard stains already matched	\$283

# RECTANGLE MILESTONE T-BASE

## Tables

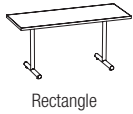

C 3MM PVC EDGES

RADIUSED CORNERS

**Required to order:** Model # including options if applicable

- HPL selection
- PVC selection (if applicable)
- wood edges finish (if applicable)
- powder coat selection

Rectangular Tables (cont.)												
Model Number	Description	Wt.	List Price	Model Number	Wt.	List Price	Model Number	Wt.	List Price	Model Number	Wt.	List Price
3mm PVC Edges with Radiused Corners				3mm PVC Edges with Radiused Corners and 2 casters			3mm PVC Edges with Radiused Corners and 4 casters			3mm PVC Edges with Radiused Corners, Flip-top and 4 casters		
MT22-C2436R-29	24"W x 36"L x 29"H, (2) 22" T Bases	57	\$1,023	MT22-C2436R-29-2C	58	\$1,067	MT22-C2436R-29-4C	59	\$1,113	MT22-C2436R-FT-29-4C	59	\$1,726
MT22-C2448R-29	24"W x 48"L x 29"H, (2) 22" T Bases	69	\$1,103	MT22-C2448R-29-2C	70	\$1,147	MT22-C2448R-29-4C	71	\$1,193	MT22-C2448R-FT-29-4C	71	\$1,806
MT22-C2460R-29	24"W x 60"L x 29"H, (2) 22" T Bases	82	\$1,171	MT22-C2460R-29-2C	83	\$1,215	MT22-C2460R-29-4C	84	\$1,260	MT22-C2460R-FT-29-4C	84	\$1,874
MT22-C2472R-29	24"W x 72"L x 29"H, (2) 22" T Bases	94	\$1,286	MT22-C2472R-29-2C	95	\$1,330	MT22-C2472R-29-4C	96	\$1,376	MT22-C2472R-FT-29-4C	96	\$2,067
MT22-C2484R-29	24"W x 84"L x 29"H, (2) 22" T Bases	110	\$1,516	MT22-C2484R-29-2C	111	\$1,560	MT22-C2484R-29-4C	112	\$1,606	MT22-C2484R-FT-29-4C	112	\$2,296
MT22-C2496R-29	24"W x 96"L x 29"H, (2) 22" T Bases	118	\$1,533	MT22-C2496R-29-2C	119	\$1,576	MT22-C2496R-29-4C	120	\$1,623	MT22-C2496R-FT-29-4C	120	\$2,313
MT22-C2436R-36	24"W x 36"L x 36"H, (2) 22" T Bases	57	\$1,204	MT22-C2436R-36-2C	58	\$1,248	MT22-C2436R-36-4C	59	\$1,294	MT22-C2436R-FT-36-4C	59	\$1,907
MT22-C2448R-36	24"W x 48"L x 36"H, (2) 22" T Bases	69	\$1,284	MT22-C2448R-36-2C	70	\$1,328	MT22-C2448R-36-4C	71	\$1,374	MT22-C2448R-FT-36-4C	71	\$1,987
MT22-C2460R-36	24"W x 60"L x 36"H, (2) 22" T Bases	82	\$1,352	MT22-C2460R-36-2C	83	\$1,395	MT22-C2460R-36-4C	84	\$1,442	MT22-C2460R-FT-36-4C	84	\$2,055
MT22-C2472R-36	24"W x 72"L x 36"H, (2) 22" T Bases	94	\$1,467	MT22-C2472R-36-2C	95	\$1,511	MT22-C2472R-36-4C	96	\$1,557	MT22-C2472R-FT-36-4C	96	\$2,248
MT22-C2484R-36	24"W x 84"L x 36"H, (2) 22" T Bases	110	\$1,697	MT22-C2484R-36-2C	111	\$1,742	MT22-C2484R-36-4C	112	\$1,787	MT22-C2484R-FT-36-4C	112	\$2,477
MT22-C2496R-36	24"W x 96"L x 36"H, (2) 22" T Bases	118	\$1,715	MT22-C2496R-36-2C	119	\$1,758	MT22-C2496R-36-4C	120	\$1,805	MT22-C2496R-FT-36-4C	120	\$2,494
MT22-C2436R-42	24"W x 36"L x 42"H, (2) 22" T Bases	57	\$1,204	MT22-C2436R-42-2C	58	\$1,248	MT22-C2436R-42-4C	59	\$1,294	MT22-C2436R-FT-42-4C	59	\$1,907
MT22-C2448R-42	24"W x 48"L x 42"H, (2) 22" T Bases	69	\$1,284	MT22-C2448R-42-2C	70	\$1,328	MT22-C2448R-42-4C	71	\$1,374	MT22-C2448R-FT-42-4C	71	\$1,987
MT22-C2460R-42	24"W x 60"L x 42"H, (2) 22" T Bases	82	\$1,352	MT22-C2460R-42-2C	83	\$1,395	MT22-C2460R-42-4C	84	\$1,442	MT22-C2460R-FT-42-4C	84	\$2,055
MT22-C2472R-42	24"W x 72"L x 42"H, (2) 22" T Bases	94	\$1,467	MT22-C2472R-42-2C	95	\$1,511	MT22-C2472R-42-4C	96	\$1,557	MT22-C2472R-FT-42-4C	96	\$2,248
MT22-C2484R-42	24"W x 84"L x 42"H, (2) 22" T Bases	110	\$1,697	MT22-C2484R-42-2C	111	\$1,742	MT22-C2484R-42-4C	112	\$1,787	MT22-C2484R-FT-42-4C	112	\$2,477
MT22-C2496R-42	24"W x 96"L x 42"H, (2) 22" T Bases	118	\$1,715	MT22-C2496R-42-2C	119	\$1,758	MT22-C2496R-42-4C	120	\$1,805	MT22-C2496R-FT-42-4C	120	\$2,494
MT26-C3036R-29	30"W x 36"L x 29"H, (2) 26" T Bases	68	\$1,092	MT26-C3036R-29-2C	69	\$1,136	MT26-C3036R-29-4C	70	\$1,182	MT26-C3036R-FT-29-4C	70	\$1,795
MT26-C3048R-29	30"W x 48"L x 29"H, (2) 26" T Bases	83	\$1,191	MT26-C3048R-29-2C	84	\$1,234	MT26-C3048R-29-4C	85	\$1,280	MT26-C3048R-FT-29-4C	85	\$1,893
MT26-C3060R-29	30"W x 60"L x 29"H, (2) 26" T Bases	97	\$1,257	MT26-C3060R-29-2C	98	\$1,302	MT26-C3060R-29-4C	99	\$1,348	MT26-C3060R-FT-29-4C	99	\$1,960
MT26-C3072R-29	30"W x 72"L x 29"H, (2) 26" T Bases	112	\$1,351	MT26-C3072R-29-2C	113	\$1,394	MT26-C3072R-29-4C	114	\$1,440	MT26-C3072R-FT-29-4C	114	\$2,131
MT26-C3084R-29	30"W x 84"L x 29"H, (2) 26" T Bases	124	\$1,653	MT26-C3084R-29-2C	125	\$1,697	MT26-C3084R-29-4C	126	\$1,744	MT26-C3084R-FT-29-4C	126	\$2,433
MT26-C3036R-36	30"W x 36"L x 36"H, (2) 26" T Bases	68	\$1,273	MT26-C3036R-36-2C	69	\$1,316	MT26-C3036R-36-4C	70	\$1,364	MT26-C3036R-FT-36-4C	70	\$1,977
MT26-C3048R-36	30"W x 48"L x 36"H, (2) 26" T Bases	83	\$1,372	MT26-C3048R-36-2C	84	\$1,415	MT26-C3048R-36-4C	85	\$1,462	MT26-C3048R-FT-36-4C	85	\$2,074
MT26-C3060R-36	30"W x 60"L x 36"H, (2) 26" T Bases	97	\$1,438	MT26-C3060R-36-2C	98	\$1,483	MT26-C3060R-36-4C	99	\$1,529	MT26-C3060R-FT-36-4C	99	\$2,142
MT26-C3072R-36	30"W x 72"L x 36"H, (2) 26" T Bases	112	\$1,532	MT26-C3072R-36-2C	113	\$1,575	MT26-C3072R-36-4C	114	\$1,622	MT26-C3072R-FT-36-4C	114	\$2,312
MT26-C3084R-36	30"W x 84"L x 36"H, (2) 26" T Bases	124	\$1,834	MT26-C3084R-36-2C	125	\$1,878	MT26-C3084R-36-4C	126	\$1,925	MT26-C3084R-FT-36-4C	126	\$2,615
MT26-C3036R-42	30"W x 36"L x 42"H, (2) 26" T Bases	68	\$1,273	MT26-C3036R-42-2C	69	\$1,316	MT26-C3036R-42-4C	70	\$1,364	MT26-C3036R-FT-42-4C	70	\$1,977
MT26-C3048R-42	30"W x 48"L x 42"H, (2) 26" T Bases	83	\$1,372	MT26-C3048R-42-2C	84	\$1,415	MT26-C3048R-42-4C	85	\$1,462	MT26-C3048R-FT-42-4C	85	\$2,074
MT26-C3060R-42	30"W x 60"L x 42"H, (2) 26" T Bases	97	\$1,438	MT26-C3060R-42-2C	98	\$1,483	MT26-C3060R-42-4C	99	\$1,529	MT26-C3060R-FT-42-4C	99	\$2,142

# RECTANGLE MILESTONE T-BASE

## Tables

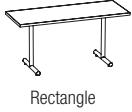

C 3MM PVC EDGES



RADIUSED CORNERS

**Required to order:** Model # including options if applicable

- HPL selection
- PVC selection (if applicable)
- wood edges finish (if applicable)
- powder coat selection

Rectangular Tables (cont.)												
Model Number	Description	Wt.	List Price	Model Number	Wt.	List Price	Model Number	Wt.	List Price	Model Number	Wt.	List Price
MT26-C3072R-42	30"W x 72"L x 42"H, (2) 26" T Bases	112	\$1,532	MT26-C3072R-42-2C	113	\$1,575	MT26-C3072R-42-4C	114	\$1,622	MT26-C3072R-FT-42-4C	114	\$2,312
MT26-C3084R-42	30"W x 84"L x 42"H, (2) 26" T Bases	124	\$1,834	MT26-C3084R-42-2C	125	\$1,878	MT26-C3084R-42-4C	126	\$1,925	MT26-C3084R-FT-42-4C	126	\$2,615
MT26-C3648R-29	36"W x 48"L x 29"H, (2) 26" T Bases	83	\$1,215	MT26-C3648R-29-2C	84	\$1,258	MT26-C3648R-29-4C	85	\$1,305	MT26-C3648R-FT-29-4C	85	\$1,917
MT26-C3660R-29	36"W x 60"L x 29"H, (2) 26" T Bases	110	\$1,324	MT26-C3660R-29-2C	111	\$1,367	MT26-C3660R-29-4C	112	\$1,413	MT26-C3660R-FT-29-4C	112	\$2,026
MT26-C3672R-29	36"W x 72"L x 29"H, (2) 26" T Bases	127	\$1,403	MT26-C3672R-29-2C	128	\$1,446	MT26-C3672R-29-4C	129	\$1,492	MT26-C3672R-FT-29-4C	129	\$2,183
MT26-C3684R-29	36"W x 84"L x 29"H, (2) 26" T Bases	139	\$1,725	MT26-C3684R-29-2C	140	\$1,769	MT26-C3684R-29-4C	141	\$1,814	MT26-C3684R-FT-29-4C	141	\$2,506
MT26-C3696R-29	36"W x 96"L x 29"H, (2) 26" T Bases	144	\$1,749	MT26-C3696R-29-2C	145	\$1,793	MT26-C3696R-29-4C	146	\$1,838	MT26-C3696R-FT-29-4C	146	\$2,530
MT26-C3648R-36	36"W x 48"L x 36"H, (2) 26" T Bases	83	\$1,395	MT26-C3648R-36-2C	84	\$1,439	MT26-C3648R-36-4C	85	\$1,486	MT26-C3648R-FT-36-4C	85	\$2,098
MT26-C3660R-36	36"W x 60"L x 36"H, (2) 26" T Bases	110	\$1,505	MT26-C3660R-36-2C	111	\$1,548	MT26-C3660R-36-4C	112	\$1,594	MT26-C3660R-FT-36-4C	112	\$2,207
MT26-C3672R-36	36"W x 72"L x 36"H, (2) 26" T Bases	127	\$1,585	MT26-C3672R-36-2C	128	\$1,628	MT26-C3672R-36-4C	129	\$1,674	MT26-C3672R-FT-36-4C	129	\$2,364
MT26-C3684R-36	36"W x 84"L x 36"H, (2) 26" T Bases	139	\$1,906	MT26-C3684R-36-2C	140	\$1,950	MT26-C3684R-36-4C	141	\$1,995	MT26-C3684R-FT-36-4C	141	\$2,687
MT26-C3696R-36	36"W x 96"L x 36"H, (2) 26" T Bases	144	\$1,930	MT26-C3696R-36-2C	145	\$1,973	MT26-C3696R-36-4C	146	\$2,020	MT26-C3696R-FT-36-4C	146	\$2,710
MT26-C3648R-42	36"W x 48"L x 42"H, (2) 26" T Bases	83	\$1,395	MT26-C3648R-42-2C	84	\$1,439	MT26-C3648R-42-4C	85	\$1,486	MT26-C3648R-FT-42-4C	85	\$2,098
MT26-C3660R-42	36"W x 60"L x 42"H, (2) 26" T Bases	110	\$1,505	MT26-C3660R-42-2C	111	\$1,548	MT26-C3660R-42-4C	112	\$1,594	MT26-C3660R-FT-42-4C	112	\$2,207
MT26-C3672R-42	36"W x 72"L x 42"H, (2) 26" T Bases	127	\$1,585	MT26-C3672R-42-2C	128	\$1,628	MT26-C3672R-42-4C	129	\$1,674	MT26-C3672R-FT-42-4C	129	\$2,364
MT26-C3684R-42	36"W x 84"L x 42"H, (2) 26" T Bases	139	\$1,906	MT26-C3684R-42-2C	140	\$1,950	MT26-C3684R-42-4C	141	\$1,995	MT26-C3684R-FT-42-4C	141	\$2,687
MT26-C3696R-42	36"W x 96"L x 42"H, (2) 26" T Bases	144	\$1,930	MT26-C3696R-42-2C	145	\$1,973	MT26-C3696R-42-4C	146	\$2,020	MT26-C3696R-FT-42-4C	146	\$2,710

### Set Up Charges and Upcharges for Non-Standard and Custom Finishes

Model Number	Description	List Price
Group 2 Powder Coat	Set up charge, per color, per order, for Group 2 Powder Coat	\$329
Non-Standard PVC	Upcharge, per color, per order, for non-standard PVC	\$911
Custom Finish	Upcharge for custom stain finish	\$640
Non-Standard Stain	Upcharge for non-standard stains already matched	\$283











# RECTANGLE MILESTONE T-BASE

## Tables

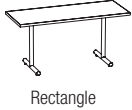

Rectangle



G 1-1/4" WOOD BULLNOSE EDGES

**Required to order:** Model # including options if applicable

- HPL selection
- PVC selection (if applicable)
- wood edges finish (if applicable)
- powder coat selection

Rectangular Tables (cont.)												
Model Number	Description	Wt.	List Price	Model Number	Wt.	List Price	Model Number	Wt.	List Price	Model Number	Wt.	List Price
MTT36-L4896-29	48"W x 96"L x 29"H, (3) 36" TT Bases	201	\$2,624									
MTT36-L48120-29	48"W x 120"L x 29"H, (3) 36" TT Bases	263	\$3,515									
MTT36-L48144-29	48"W x 144"L x 29"H, (3) 36" TT Bases	302	\$3,911									
MTT36-L6072-29	60"W x 72"L x 29"H, (2) 36" TT Bases	213	\$4,392									
MTT36-L6096-29	60"W x 96"L x 29"H, (3) 36" TT Bases	275	\$5,232									
MTT36-L60120-29	60"W x 120"L x 29"H, (3) 36" TT Bases	371	\$6,125									
MTT36-L60144-29	60"W x 144"L x 29"H, (3) 36" TT Bases	434	\$7,116									

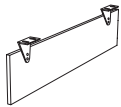

Floating Modesty Panels			
Model Number	Description	Wt.	List Price
<b>Veneer Finish</b>			
M-36MODV	27"L x 12"H	13	\$298
M-48MODV	39"L x 12"H	18	\$336
M-60MODV	51"L x 12"H	22	\$358
M-72MODV	63"L x 12"H	27	\$414
<b>Laminate Finish</b>			
M-36MODL	27"L x 12"H	13	\$298
M-48MODL	39"L x 12"H	18	\$336
M-60MODL	51"L x 12"H	22	\$358
M-72MODL	63"L x 12"H	27	\$414



Surfboard Markerboard and Accessories			
Model Number	Description	Wgt	List Price
SFB-1824	Surfboard Marker Board, 18"W x 24"L		\$225
SFB-1824-8PACK	(8) Surfboard Markerboards		\$1,546
SFB-1824-5PACK	(5) Surfboard Markerboards		\$987
SFB-SMB	Table Side Mounting Bracket for Surfboard - available in full range of powder coat colors.		\$85
SFB-TMB	Table Top Mounting Bracket for Surfboard - available in black		\$85
HTSBB	Surfboard hanging bracket for elements track.		\$82

Available Separately

Set Up Charges and Upcharges for Non-Standard and Custom Finishes		
Model Number	Description	List Price
Group 2 Powder Coat	Set up charge, per color, per order, for Group 2 Powder Coat	\$329
Non-Standard PVC	Upcharge, per color, per order, for non-standard PVC	\$911
Custom Finish	Upcharge for custom stain finish	\$640
Non-Standard Stain	Upcharge for non-standard stains already matched	\$283

Surfboard Cart			
Model Number	Description	Wgt	List Price
SFBC-2446-55-MOB	Surfboard Cart, 24"D x 45.5"W x 54.5"H, Mobile	200	\$3,283

# TRAPEZOID MILESTONE T-BASE

## Tables



**Required to order:** Model # including options if applicable

- HPL selection
- PVC selection (if applicable)
- wood edges finish (if applicable)
- powder coat selection

				Trapezoid Tables with 22"							
Model Number	Description	Wt.	List Price	Description	Wt.	List Price	Description	Wt.	List Price		
										3mm PVC Edges	3mm PVC Edges and 2 casters
MT22-C2448TRAP-29	24"W x 48"L x 29"H	57	\$1,007	MT22-C2448TRAP-29-2C	58	\$1,050	MT22-C2448TRAP-29-4C	59	\$1,093		
MT22-C2448TRAP-36	24"W x 48"L x 36"H	61	\$1,188	MT22-C2448TRAP-36-2C	62	\$1,231	MT22-C2448TRAP-36-4C	63	\$1,273		
MT22-C2448TRAP-42	24"W x 48"L x 42"H	63	\$1,188	MT22-C2448TRAP-42-2C	64	\$1,231	MT22-C2448TRAP-42-4C	65	\$1,273		
MT22-C3060TRAP-29	30"W x 60"L x 29"H	78	\$1,231	MT22-C3060TRAP-29-2C	79	\$1,275	MT22-C3060TRAP-29-4C	80	\$1,316		
MT22-C3060TRAP-36	30"W x 60"L x 36"H	82	\$1,408	MT22-C3060TRAP-36-2C	83	\$1,452	MT22-C3060TRAP-36-4C	84	\$1,494		
MT22-C3060TRAP-42	30"W x 60"L x 42"H	84	\$1,408	MT22-C3060TRAP-42-2C	85	\$1,452	MT22-C3060TRAP-42-4C	86	\$1,494		
MT22-C3072TRAP-29	30"W x 72"L x 29"H	89	\$1,349	MT22-C3072TRAP-29-2C	90	\$1,392	MT22-C3072TRAP-29-4C	91	\$1,435		
MT22-C3072TRAP-36	30"W x 72"L x 36"H	93	\$1,525	MT22-C3072TRAP-36-2C	94	\$1,569	MT22-C3072TRAP-36-4C	95	\$1,612		
MT22-C3072TRAP-42	30"W x 72"L x 42"H	95	\$1,525	MT22-C3072TRAP-42-2C	96	\$1,569	MT22-C3072TRAP-42-4C	97	\$1,612		
MT22-C3672TRAP-29	36"W x 72"L x 29"H	101	\$1,489	MT22-C3672TRAP-29-2C	102	\$1,533	MT22-C3672TRAP-29-4C	103	\$1,575		
MT22-C3672TRAP-36	36"W x 72"L x 36"H	105	\$1,667	MT22-C3672TRAP-36-2C	106	\$1,710	MT22-C3672TRAP-36-4C	107	\$1,753		
MT22-C3672TRAP-42	36"W x 72"L x 42"H	107	\$1,667	MT22-C3672TRAP-42-2C	108	\$1,710	MT22-C3672TRAP-42-4C	109	\$1,753		
3mm Wood Edges				3mm Wood Edges and 2 casters				3mm Wood Edges and 4 casters			
MT22-E2448TRAP-29	24"W x 48"L x 29"H	57	\$1,199	MT22-E2448TRAP-29-2C	58	\$1,244	MT22-E2448TRAP-29-4C	59	\$1,286		
MT22-E2448TRAP-36	24"W x 48"L x 36"H	61	\$1,377	MT22-E2448TRAP-36-2C	62	\$1,420	MT22-E2448TRAP-36-4C	63	\$1,464		
MT22-E2448TRAP-42	24"W x 48"L x 42"H	63	\$1,377	MT22-E2448TRAP-42-2C	64	\$1,420	MT22-E2448TRAP-42-4C	65	\$1,464		
MT22-E3060TRAP-29	30"W x 60"L x 29"H	78	\$1,507	MT22-E3060TRAP-29-2C	79	\$1,550	MT22-E3060TRAP-29-4C	80	\$1,593		
MT22-E3060TRAP-36	30"W x 60"L x 36"H	82	\$1,685	MT22-E3060TRAP-36-2C	83	\$1,729	MT22-E3060TRAP-36-4C	84	\$1,772		
MT22-E3060TRAP-42	30"W x 60"L x 42"H	84	\$1,685	MT22-E3060TRAP-42-2C	85	\$1,729	MT22-E3060TRAP-42-4C	86	\$1,772		
MT22-E3072TRAP-29	30"W x 72"L x 29"H	89	\$1,684	MT22-E3072TRAP-29-2C	90	\$1,728	MT22-E3072TRAP-29-4C	91	\$1,771		
MT22-E3072TRAP-36	30"W x 72"L x 36"H	93	\$1,860	MT22-E3072TRAP-36-2C	94	\$1,905	MT22-E3072TRAP-36-4C	95	\$1,947		
MT22-E3072TRAP-42	30"W x 72"L x 42"H	95	\$1,860	MT22-E3072TRAP-42-2C	96	\$1,905	MT22-E3072TRAP-42-4C	97	\$1,947		
MT22-E3672TRAP-29	36"W x 72"L x 29"H	101	\$1,836	MT22-E3672TRAP-29-2C	102	\$1,880	MT22-E3672TRAP-29-4C	103	\$1,924		
MT22-E3672TRAP-36	36"W x 72"L x 36"H	105	\$2,015	MT22-E3672TRAP-36-2C	106	\$2,059	MT22-E3672TRAP-36-4C	107	\$2,102		
MT22-E3672TRAP-42	36"W x 72"L x 42"H	107	\$2,015	MT22-E3672TRAP-42-2C	108	\$2,059	MT22-E3672TRAP-42-4C	109	\$2,102		
5/8" Wood Bullnose Edges				5/8" Wood Bullnose Edges and 2 casters				5/8" Wood Bullnose Edges and 4 casters			
MT22-G2448TRAP-29	24"W x 48"L x 29"H	57	\$1,391	MT22-G2448TRAP-29-2C	58	\$1,435	MT22-G2448TRAP-29-4C	59	\$1,478		
MT22-G2448TRAP-36	24"W x 48"L x 36"H	61	\$1,566	MT22-G2448TRAP-36-2C	62	\$1,610	MT22-G2448TRAP-36-4C	63	\$1,652		
MT22-G2448TRAP-42	24"W x 48"L x 42"H	63	\$1,566	MT22-G2448TRAP-42-2C	64	\$1,610	MT22-G2448TRAP-42-4C	65	\$1,652		
MT22-G3060TRAP-29	30"W x 60"L x 29"H	78	\$1,708	MT22-G3060TRAP-29-2C	79	\$1,752	MT22-G3060TRAP-29-4C	80	\$1,795		
MT22-G3060TRAP-36	30"W x 60"L x 36"H	82	\$1,887	MT22-G3060TRAP-36-2C	83	\$1,931	MT22-G3060TRAP-36-4C	84	\$1,973		
MT22-G3060TRAP-42	30"W x 60"L x 42"H	84	\$1,887	MT22-G3060TRAP-42-2C	85	\$1,931	MT22-G3060TRAP-42-4C	86	\$1,973		
MT22-G3072TRAP-29	30"W x 72"L x 29"H	89	\$1,856	MT22-G3072TRAP-29-2C	90	\$1,900	MT22-G3072TRAP-29-4C	91	\$1,943		
MT22-G3072TRAP-36	30"W x 72"L x 36"H	93	\$2,032	MT22-G3072TRAP-36-2C	94	\$2,075	MT22-G3072TRAP-36-4C	95	\$2,118		
MT22-G3072TRAP-42	30"W x 72"L x 42"H	95	\$2,032	MT22-G3072TRAP-42-2C	96	\$2,075	MT22-G3072TRAP-42-4C	97	\$2,118		
MT22-G3672TRAP-29	36"W x 72"L x 29"H	101	\$1,991	MT22-G3672TRAP-29-2C	102	\$2,035	MT22-G3672TRAP-29-4C	103	\$2,077		
MT22-G3672TRAP-36	36"W x 72"L x 36"H	105	\$2,170	MT22-G3672TRAP-36-2C	106	\$2,214	MT22-G3672TRAP-36-4C	107	\$2,256		
MT22-G3672TRAP-42	36"W x 72"L x 42"H	107	\$2,170	MT22-G3672TRAP-42-2C	108	\$2,214	MT22-G3672TRAP-42-4C	109	\$2,256		
1-1/4" Wood Bullnose Edges				1-1/4" Wood Bullnose Edges and 2 casters				1-1/4" Wood Bullnose Edges and 4 casters			
MT22-L2448TRAP-29	24"W x 48"L x 29"H	57	\$1,494	MT22-L2448TRAP-29-2C	58	\$1,538	MT22-L2448TRAP-29-4C	59	\$1,579		
MT22-L2448TRAP-36	24"W x 48"L x 36"H	61	\$1,671	MT22-L2448TRAP-36-2C	62	\$1,715	MT22-L2448TRAP-36-4C	63	\$1,757		
MT22-L2448TRAP-42	24"W x 48"L x 42"H	63	\$1,671	MT22-L2448TRAP-42-2C	64	\$1,715	MT22-L2448TRAP-42-4C	65	\$1,757		
MT22-L3060TRAP-29	30"W x 60"L x 29"H	78	\$1,838	MT22-L3060TRAP-29-2C	79	\$1,883	MT22-L3060TRAP-29-4C	80	\$1,926		
MT22-L3060TRAP-36	30"W x 60"L x 36"H	82	\$2,017	MT22-L3060TRAP-36-2C	83	\$2,062	MT22-L3060TRAP-36-4C	84	\$2,104		
MT22-L3060TRAP-42	30"W x 60"L x 42"H	84	\$2,017	MT22-L3060TRAP-42-2C	85	\$2,062	MT22-L3060TRAP-42-4C	86	\$2,104		
MT22-L3072TRAP-29	30"W x 72"L x 29"H	89	\$2,076	MT22-L3072TRAP-29-2C	90	\$2,120	MT22-L3072TRAP-29-4C	91	\$2,164		
MT22-L3072TRAP-36	30"W x 72"L x 36"H	93	\$2,256	MT22-L3072TRAP-36-2C	94	\$2,300	MT22-L3072TRAP-36-4C	95	\$2,343		
MT22-L3072TRAP-42	30"W x 72"L x 42"H	95	\$2,256	MT22-L3072TRAP-42-2C	96	\$2,300	MT22-L3072TRAP-42-4C	97	\$2,343		
MT22-L3672TRAP-29	36"W x 72"L x 29"H	101	\$2,194	MT22-L3672TRAP-29-2C	102	\$2,237	MT22-L3672TRAP-29-4C	103	\$2,280		
MT22-L3672TRAP-36	36"W x 72"L x 36"H	105	\$2,372	MT22-L3672TRAP-36-2C	106	\$2,415	MT22-L3672TRAP-36-4C	107	\$2,457		
MT22-L3672TRAP-42	36"W x 72"L x 42"H	107	\$2,372	MT22-L3672TRAP-42-2C	108	\$2,415	MT22-L3672TRAP-42-4C	109	\$2,457		

# SPROCKET/BEANIE/FLAIR MILESTONE T-BASE

## Tables



Sprocket



C 3MM PVC EDGES

**Required to order:** Model # including options if applicable

- HPL selection
- PVC selection (if applicable)
- wood edges finish (if applicable)
- powder coat selection



Beanie



C 3MM PVC EDGES



Flair



C 3MM PVC EDGES

### Set Up Charges and Upcharges for Non-Standard and Custom Finishes

Model Number	Description	List Price
Group 2 Powder Coat	Set up charge, per color, per order, for Group 2 Powder Coat	\$329
Non-Standard PVC	Upcharge, per color, per order, for non-standard PVC	\$911
Custom Finish	Upcharge for custom stain finish	\$640
Non-Standard Stain	Upcharge for non-standard stains already matched	\$283

# RACETRACK MILESTONE T-BASE

## Tables

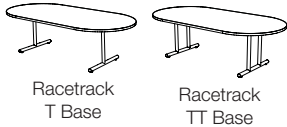

**Required to order:** Model # including options if applicable

- HPL selection
- PVC selection (if applicable)
- wood edges finish (if applicable)
- powder coat selection

				Racetrack Tables							
Model Number	Description	Wgt	List Price	Model Number	Wgt	List Price	Model Number	List Price	Model Number	Wgt	List Price
				3mm PVC Edges		3mm PVC Edges and 2 Casters		3mm PVC Edges and 4 Casters		3mm PVC Edges with 4 Casters and Flip-top base	
MT26-CRT3672-29	36"W x 72"L x 29"H, (2) 26" T bases	118	\$1,391	MT26-CRT3672-29-2C	119	\$1,377	MT26-CRT3672-29-4C	\$1,347	MT26-CRT3672-FT-29-4C	120	\$2,080
MTT30-CRT4896-29	48"W x 96"L x 29"H, (3) 30" TT bases	210	\$2,613								
MTT30-CRT48120-29	48"W x 120"L x 29"H, (2) 30" TT bases	282	\$3,893								
MTT30-CRT48144-29	48"W x 144"L x 29"H, (3) 30" TT bases	365	\$4,448								
MTT36-CRT6096-29	60"W x 96"L x 29"H, (3) 36" TT bases	250	\$3,683								
MTT36-CRT60120-29	60"W x 120"L x 29"H, (3) 36" TT bases	342	\$5,118								
MTT36-CRT60144-29	60"W x 144"L x 29"H, (3) 36" TT bases	432	\$5,709								
				8mm Wood Edges		8mm Wood Edges and 2 Casters		8mm Wood Edges and 4 Casters		8mm Wood Edges with 4 Casters and Flip-top base	
MT26-FRT3672-29	36"W x 72"L x 29"H, (2) 26" T bases	118	1833	MT26-FRT3672-29-2C	119	\$1,877	MT26-FRT3672-29-4C	\$1,823	MT26-FRT3672-FT-29-4C	120	\$2,610
MTT30-FRT4896-29	48"W x 96"L x 29"H, (3) 30" TT bases	210	\$3,173								
MTT30-FRT48120-29	48"W x 120"L x 29"H, (2) 30" TT bases	282	\$4,332								
MTT30-FRT48144-29	48"W x 144"L x 29"H, (3) 30" TT bases	365	\$5,282								
MTT36-FRT6096-29	60"W x 96"L x 29"H, (3) 36" TT bases	250	\$4,008								
MTT36-FRT60120-29	60"W x 120"L x 29"H, (3) 36" TT bases	342	\$5,567								
MTT36-FRT60144-29	60"W x 144"L x 29"H, (3) 36" TT bases	432	\$6,355								
				5/8" Wood Bullnose Edges		5/8" Wood Bullnose Edges and 2 Casters		5/8" Wood Bullnose Edges and 4 Casters		5/8" Wood Bullnose Edges with 4 Casters and Flip-top base	
MT26-GRT3672-29	36"W x 72"L x 29"H, (2) 26" T bases	118	\$2,228	MT26-GRT3672-29-2C	119	\$2,272	MT26-GRT3672-29-4C	\$2,198	MT26-GRT3672-FT-29-4C	120	\$3,005
MTT30-GRT4896-29	48"W x 96"L x 29"H, (3) 30" TT bases	210	\$3,492								
MTT30-GRT48120-29	48"W x 120"L x 29"H, (2) 30" TT bases	282	\$4,768								
MTT30-GRT48144-29	48"W x 144"L x 29"H, (3) 30" TT bases	365	\$5,808								
MTT36-GRT6096-29	60"W x 96"L x 29"H, (3) 36" TT bases	250	\$4,408								
MTT36-GRT60120-29	60"W x 120"L x 29"H, (3) 36" TT bases	342	\$6,124								
MTT36-GRT60144-29	60"W x 144"L x 29"H, (3) 36" TT bases	432	\$6,989								
				1-1/4" Wood Bullnose Edges		1-1/4" Wood Bullnose Edges and 2 Casters		1-1/4" Wood Bullnose Edges and 4 Casters		1-1/4" Wood Bullnose Edges with 4 Casters and Flip-top base	
MT26-LRT3672-29	36"W x 72"L x 29"H, (2) 26" T bases	118	\$2,795	MT26-LRT3672-29-2C	119	\$2,838	MT26-LRT3672-29-4C	\$2,737	MT26-LRT3672-FT-29-4C	120	\$3,571
MTT30-LRT4896-29	48"W x 96"L x 29"H, (3) 30" TT bases	210	\$4,748								
MTT30-LRT48120-29	48"W x 120"L x 29"H, (2) 30" TT bases	282	\$6,069								
MTT30-LRT48144-29	48"W x 144"L x 29"H, (3) 30" TT bases	365	\$7,273								
MTT36-LRT6096-29	60"W x 96"L x 29"H, (3) 36" TT bases	250	\$5,272								
MTT36-LRT60120-29	60"W x 120"L x 29"H, (3) 36" TT bases	342	\$6,743								
MTT36-LRT60144-29	60"W x 144"L x 29"H, (3) 36" TT bases	432	\$8,152								
<b>(4 indicates availability) Folding Base Option</b>											
Add Suffix to Model Number	Description	Wgt	List Price								
-F	Provides positive lock in up and down position		\$508								
<b>Rock-n-Roll Base Option</b>											
Add Suffix to Model Number	Description	Wgt	List Price								
-RR	For tables using single T bases										
<b>Twin Wheel Locking Casters</b>											
Add Suffix to Model Number	Description	Wgt	List Price								
-2C	Set of 2 Casters	1	\$43								
-4C	Set of 4 Casters	2	\$74								

# BOAT MILESTONE T-BASE

## Tables



Boat T Base



Boat TT Base

**Required to order:** Model # including options if applicable

- HPL selection
- PVC selection (if applicable)
- wood edges finish (if applicable)
- powder coat selection

Boat Tables												
Model Number	Description	Wt	List Price	Model Number	Wt	List Price	Model Number	Wt	List Price	Model Number	Wt	List Price
3mm PVC Edges				3mm PVC Edges and 2 casters			3mm PVC Edges and 4 casters			3mm PVC Edges with 4 casters and Flip-top base		
MT26-CBT30/3672-29	30/36"W x 72"L x 29"H, (2) 26" T bases	118	\$1,391	MT26-CBT30/3672-29-2C	119	\$1,435	MT26-CBT30/3672-29-4C	120	\$1,478	MT26-CBT30/3672-FT-29-4C	120	\$2,012
MTT30-CBT36/4896-29	48"W x 96"L x 29"H, (2) 30" TT Bases	210	\$2,613									
MTT30-CBT36/48120-29	48"W x 120"L x 29"H, (3) 30" TT bases	282	\$3,893									
MTT30-CBT36/48144-29	48"W x 144"L x 29"H, (3) 30" TT bases	365	\$4,448									
MTT36-CBT48/6096-29	60"W x 96"L x 29"H, (3) 36" TT bases	250	\$3,683									
MTT36-CBT48/60120-29	60"W x 120"L x 29"H, (3) 36" TT bases	342	\$5,118									
MTT36-CBT48/60144-29	60"W x 144"L x 29"H, (3) 36" TT bases	415	\$5,709									
3mm Wood Edges				3mm Wood Edges and 2 casters			3mm Wood Edges and 4 casters			3mm Wood Edges with 4 casters and Flip-top base		
MT26-EBT30/3672-29	30/36"W x 72"L x 29"H, (2) 26" T bases	118	\$1,833	MT26-EBT30/3672-29-2C	119	\$1,877	MT26-EBT30/3672-29-4C	120	\$1,919	MT26-EBT30/3672-FT-29-4C	120	\$2,454
MTT30-EBT36/4896-29	48"W x 96"L x 29"H, (2) 30" TT Bases	210	\$3,173									
MTT30-EBT36/48120-29	48"W x 120"L x 29"H, (3) 30" TT bases	282	\$4,332									
MTT30-EBT36/48144-29	48"W x 144"L x 29"H, (3) 30" TT bases	365	\$5,282									
MTT36-EBT48/6096-29	60"W x 96"L x 29"H, (3) 36" TT bases	250	\$4,008									
MTT36-EBT48/60120-29	60"W x 120"L x 29"H, (3) 36" TT bases	342	\$5,567									
MTT36-EBT48/60144-29	60"W x 144"L x 29"H, (3) 36" TT bases	415	\$6,355									
8mm Wood Edges				8mm Wood Edges and 2 casters			8mm Wood Edges and 4 casters			8mm Wood Edges with 4 casters and Flip-top base		
MT26-FBT30/3672-29	30/36"W x 72"L x 29"H, (2) 26" T bases	118	\$1,833	MT26-FBT30/3672-29-2C	119	\$1,877	MT26-FBT30/3672-29-4C	120	\$1,919	MT26-FBT30/3672-FT-29-4C	120	\$2,454
MTT30-FBT36/4896-29	48"W x 96"L x 29"H, (2) 30" TT Bases	210	\$3,173									
MTT30-FBT36/48120-29	48"W x 120"L x 29"H, (3) 30" TT bases	282	\$4,332									
MTT30-FBT36/48144-29	48"W x 144"L x 29"H, (3) 30" TT bases	365	\$5,282									
MTT36-FBT48/6096-29	60"W x 96"L x 29"H, (3) 36" TT bases	250	\$4,008									
MTT36-FBT48/60120-29	60"W x 120"L x 29"H, (3) 36" TT bases	342	\$5,567									
MTT36-FBT48/60144-29	60"W x 144"L x 29"H, (3) 36" TT bases	415	\$6,355									
5/8" Wood Bullnose Edges				5/8" Wood Bullnose Edges and 2 casters			5/8" Wood Bullnose Edges and 4 casters			5/8" Wood Bullnose Edges with 4 casters and Flip-top base		
MT26-GBT30/3672-29	30/36"W x 72"L x 29"H, (2) 26" T bases	118	\$2,228	MT26-GBT30/3672-29-2C	119	\$2,272	MT26-GBT30/3672-29-4C	120	\$2,314	MT26-GBT30/3672-FT-29-4C	120	\$2,849
MTT30-GBT36/4896-29	48"W x 96"L x 29"H, (2) 30" TT Bases	210	\$3,492									
MTT30-GBT36/48120-29	48"W x 120"L x 29"H, (3) 30" TT bases	282	\$4,768									
MTT30-GBT36/48144-29	48"W x 144"L x 29"H, (3) 30" TT bases	365	\$5,808									
MTT36-GBT48/6096-29	60"W x 96"L x 29"H, (3) 36" TT bases	250	\$4,408									
MTT36-GBT48/60120-29	60"W x 120"L x 29"H, (3) 36" TT bases	342	\$6,124									
MTT36-GBT48/60144-29	60"W x 144"L x 29"H, (3) 36" TT bases	415	\$6,989									
1-1/4" Wood Bullnose Edges				1-1/4" Wood Bullnose Edges and 2 casters			1-1/4" Wood Bullnose Edges and 4 casters			1-1/4" Wood Bullnose Edges with 4 casters and Flip-top base		
MT26-LBT30/3672-29	30/36"W x 72"L x 29"H, (2) 26" T bases	118	\$2,795	MT26-LBT30/3672-29-2C	119	\$2,838	MT26-LBT30/3672-29-4C	120	\$2,882	MT26-LBT30/3672-FT-29-4C	120	\$3,415
MTT30-LBT36/4896-29	48"W x 96"L x 29"H, (2) 30" TT Bases	210	\$4,748									
MTT30-LBT36/48120-29	48"W x 120"L x 29"H, (3) 30" TT bases	282	\$6,069									
MTT30-LBT36/48144-29	48"W x 144"L x 29"H, (3) 30" TT bases	365	\$7,273									
MTT36-LBT48/6096-29	60"W x 96"L x 29"H, (3) 36" TT bases	250	\$5,272									
MTT36-LBT48/60120-29	60"W x 120"L x 29"H, (3) 36" TT bases	342	\$6,743									
MTT36-LBT48/60144-29	60"W x 144"L x 29"H, (3) 36" TT bases	415	\$8,152									

### Set Up Charges and Upcharges for Non-Standard and Custom Finishes

Model Number	Description	List Price
Group 2 Powder Coat	Set up charge, per color, per order, for Group 2 Powder Coat	\$329
Non-Standard PVC	Upcharge, per color, per order, for non-standard PVC	\$911
Custom Finish	Upcharge for custom stain finish	\$640
Non-Standard Stain	Upcharge for non-standard stains already matched	\$283