

Full Time Ottomans, Halfbacks, Quarterbacks & Ottables

Price Sheet 2024



Full Time Ottomans, Halfbacks & Ottables

Ottomans are the appetizers of the lounge furniture menu. They are a perfect perch for an impromptu gathering, an individual time out space, or a casual strategy meeting. Moveable, reconfigurable, comfortable, colorful. Delicious on their own or combine them to create your own special entrée.

Today's spaces require both flexibility and durability. Simple, combinable shapes help to simplify space planning. Mobility options help to make flexibility easy and make user-reconfigurability a snap.

Constructed on a durable wood frame and wrapped and padded in comfort-oozing high density upholstery foam, Full Time Ottomans are ready to be finished in the upholstery of your choice. Select from our impressive array of graded fabric options or feel free to provide your own special fabric selection. Your Full Time Ottomans will be performing and looking great for a long time

Full Time Ottomans are available in various sizes of the following easily configurable shapes for you to mix and match:

Round, Half Round, Crescent, Curve, Square, Rectangle, Game Controller, Halfback, Halfback Curve, Quarterback, Pentagon & Hexagon.

Like most families, the Full Time Ottoman family includes a few members that are a bit "different". **Full Time Ottables** are select Full Time Ottoman shapes with a table top! **Full Time Halfbacks** are select Full Time Ottomans that include a back. **Full Time Quarterbacks** are crescents with offset quarter backs. **Junior** versions (16" Height) are available for all.

Options:

Full Time Ottomans and Halfbacks have surfaces that can be upholstered in fabric combinations.

Full Time Ottomans and Halfbacks are available with:

- Powder coated plate steel legs with adjustable glides
- Swivel casters
- Oak post legs that you can have finished in one of our finish options.

A Power and Connectivity Option is available for flat vertical surfaces of Full Time Ottomans.

Full Time Ottables have a worksurface that is suitable for mounting many of our surface-mount connectivity options.



ROUND OTTOMANS

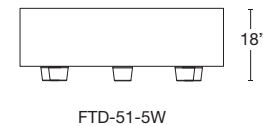
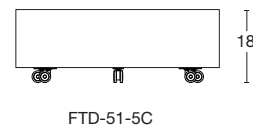
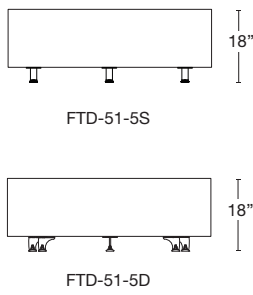
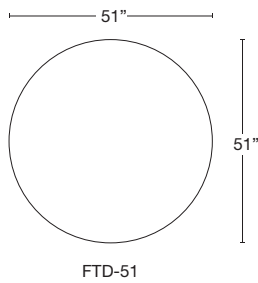
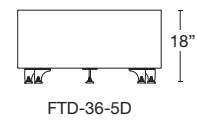
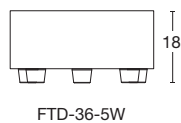
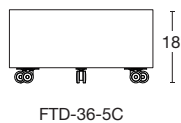
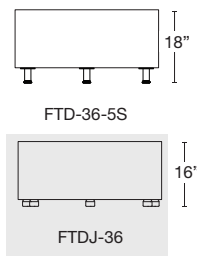
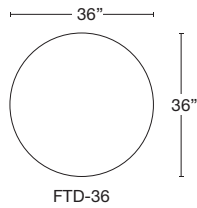
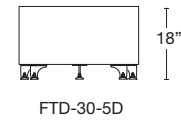
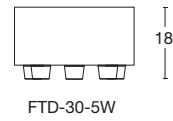
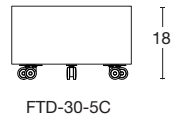
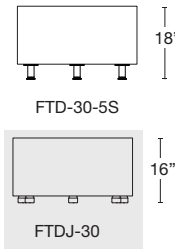
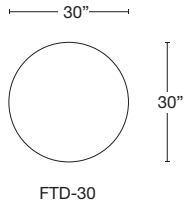
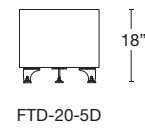
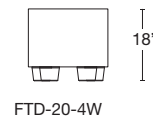
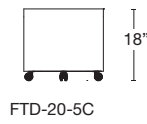
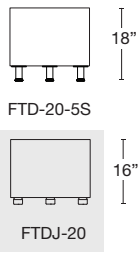
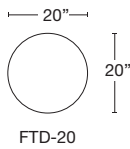
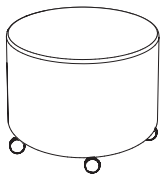

■ = Junior seat height 16"

HALF ROUND OTTOMANS

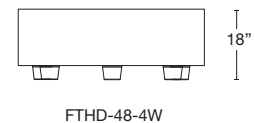
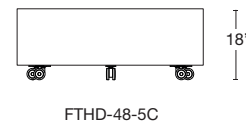
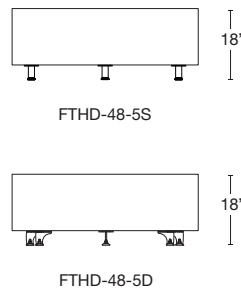
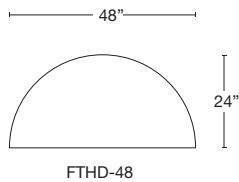
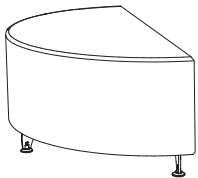

■ = Junior seat height 16"

CRESCENT OTTOMANS

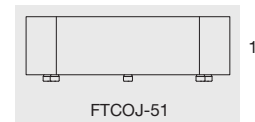
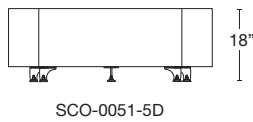
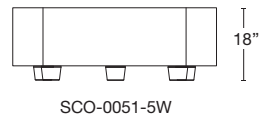
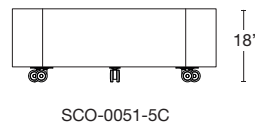
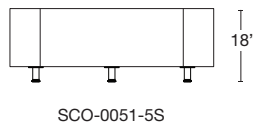
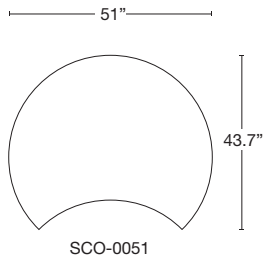
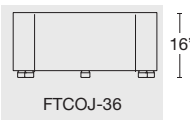
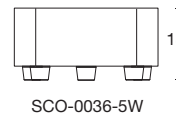
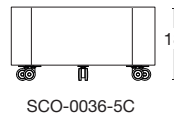
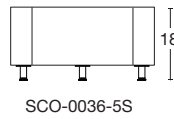
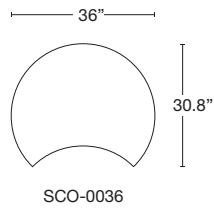
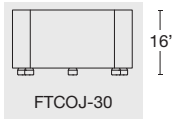
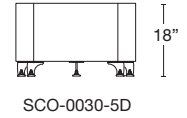
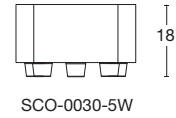
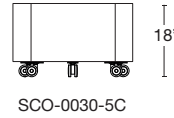
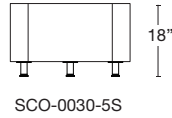
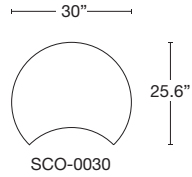
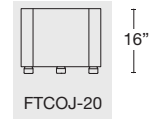
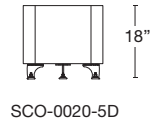
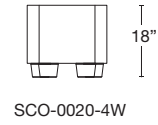
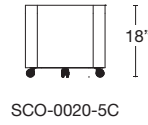
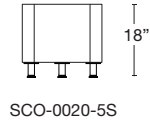
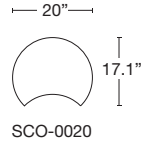
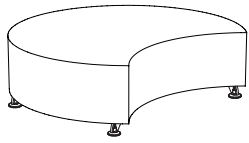

■ = Junior seat height 16"

PENTAGON OTTOMANS

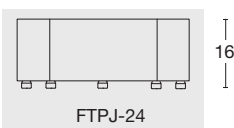
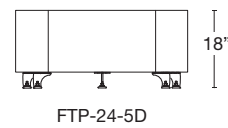
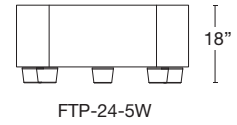
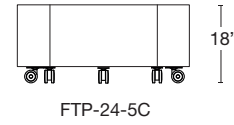
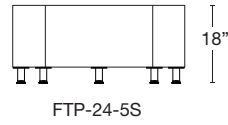
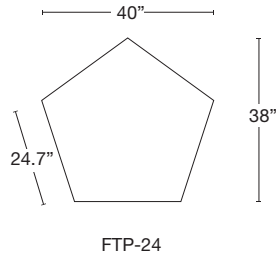
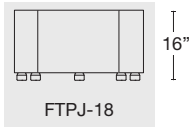
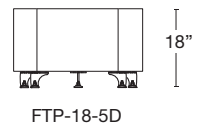
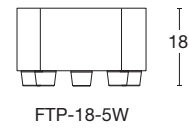
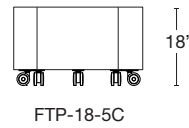
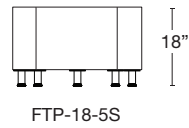
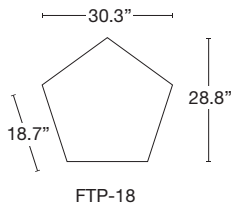
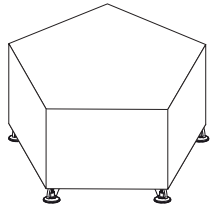

■ = Junior seat height 16"

HEXAGON OTTOMANS

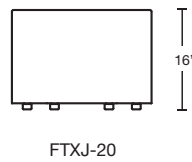
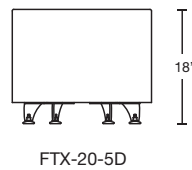
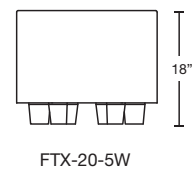
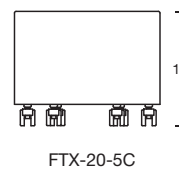
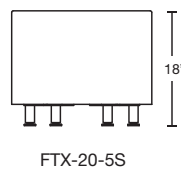
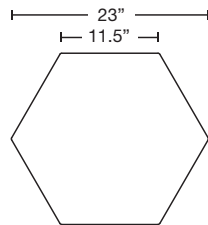
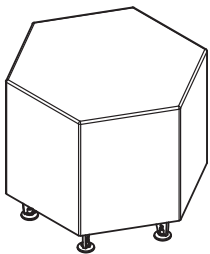

■ = Junior seat height 16"

CURVE OTTOMANS

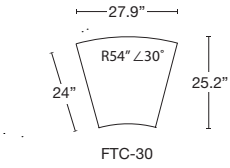
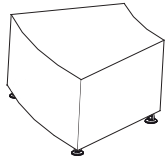

FTC-30

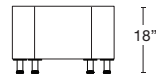

FTC-30-4S

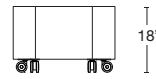

FTC-30-4C

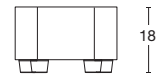

FTC-30-4W

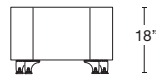

FTC-30-4D

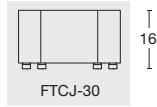

FTCJ-30

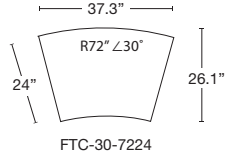

FTC-30-7224

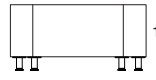

FTC-30-7224-4S

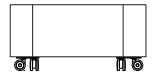

FTC-30-7224-4C

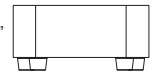

FTC-30-7224-4W

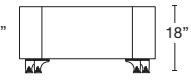

FTC-30-7224-4D

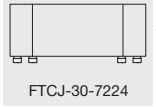

FTCJ-30-7224

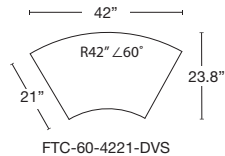

FTC-60-4221-DVS

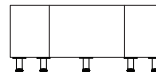

FTC-60-4221-DVS-5S

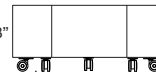

FTC-60-4221-DVS-5C

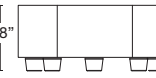

FTC-60-4221-DVS-5W

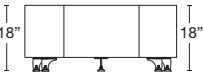

FTC-60-4221-DVS-5D

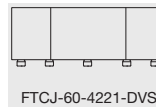

FTCJ-60-4221-DVS

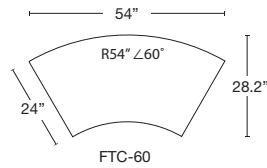

FTC-60

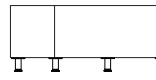

FTC-60-5S

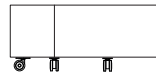

FTC-60-5C

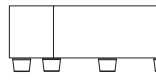

FTC-60-5W

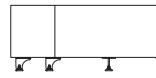

FTC-60-5D

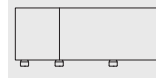

FTCJ-60

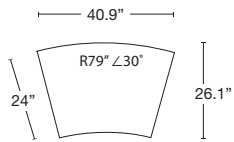

FTC-30-7924

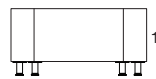

FTC-30-7924-4S

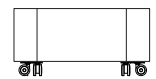

FTC-30-7924-4C

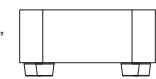

FTC-30-7924-4W

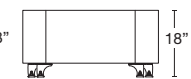

FTC-30-7924-4D

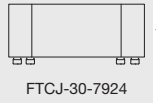

FTCJ-30-7924

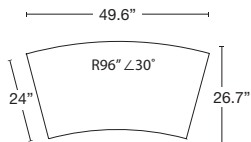

FTC-30-9624

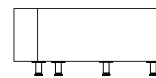

FTC-30-9624-5S

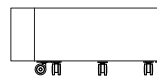

FTC-30-9624-5C

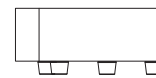

FTC-30-9624-5W

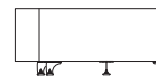

FTC-30-9624-5D

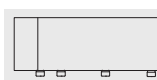

FTCJ-30-9624

R = Radius in inches
 ∠ = Curve Angle in degrees
 = Junior seat height 16"

SQUARE OTTOMANS

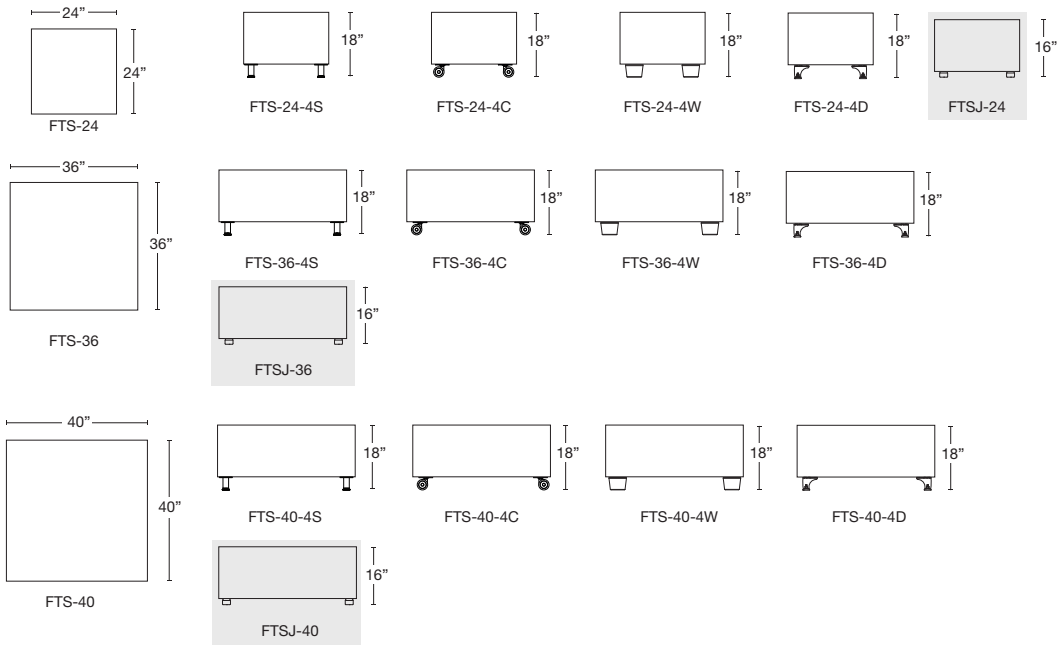
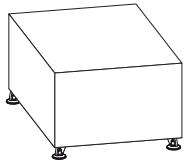

■ = Junior seat height 16"

RECTANGLE OTTOMANS

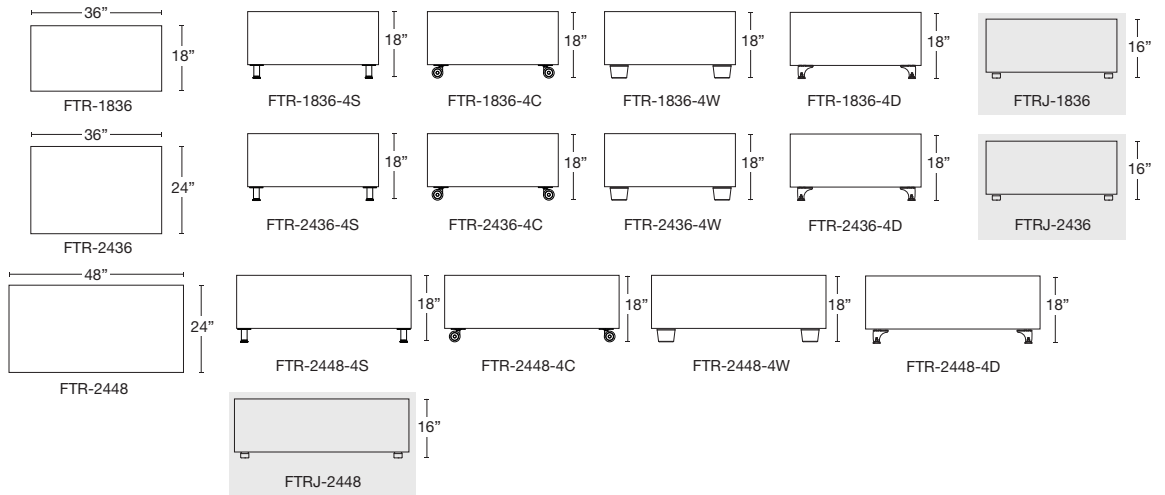
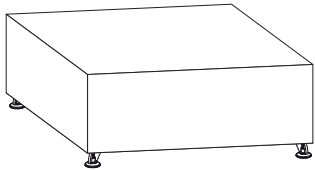

■ = Junior seat height 16"

GAME CONTROLLER OTTOMANS

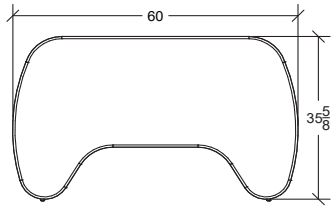

FTGC-3660-5S

FTGC-3660-5C

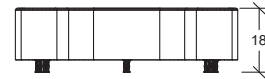
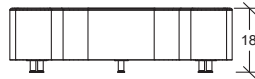

FTGC-3660-5W

FTGC-3660-5D

FTGCI-3660

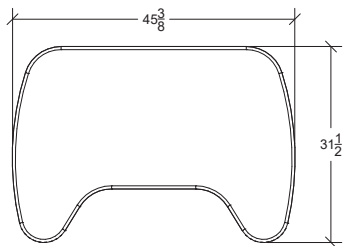
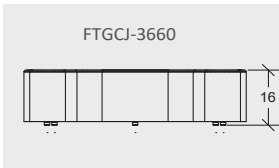
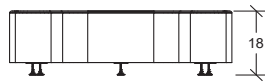
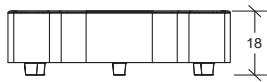

FTGC-3245-4S

FTGC-3245-4C

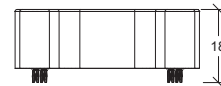
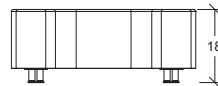

FTGC-3245-4W

FTGC-3245-4D

FTGCI-3245

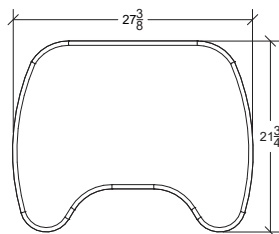
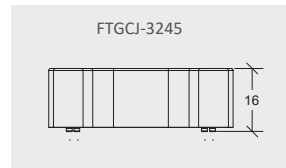
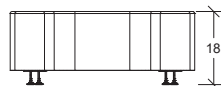
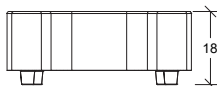

FTGC-2228-4S

FTGC-2228-4C

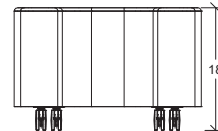
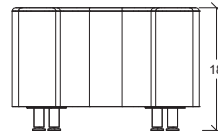

FTGC-2228-4W

FTGC-2228-4D

FTGCI-2228

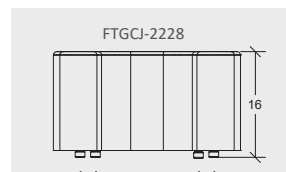
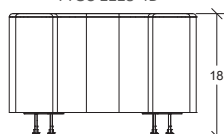
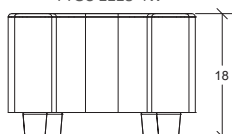

■ = Junior seat height 16"

HALFBACK SQUARE AND RECTANGLE OTTOMANS

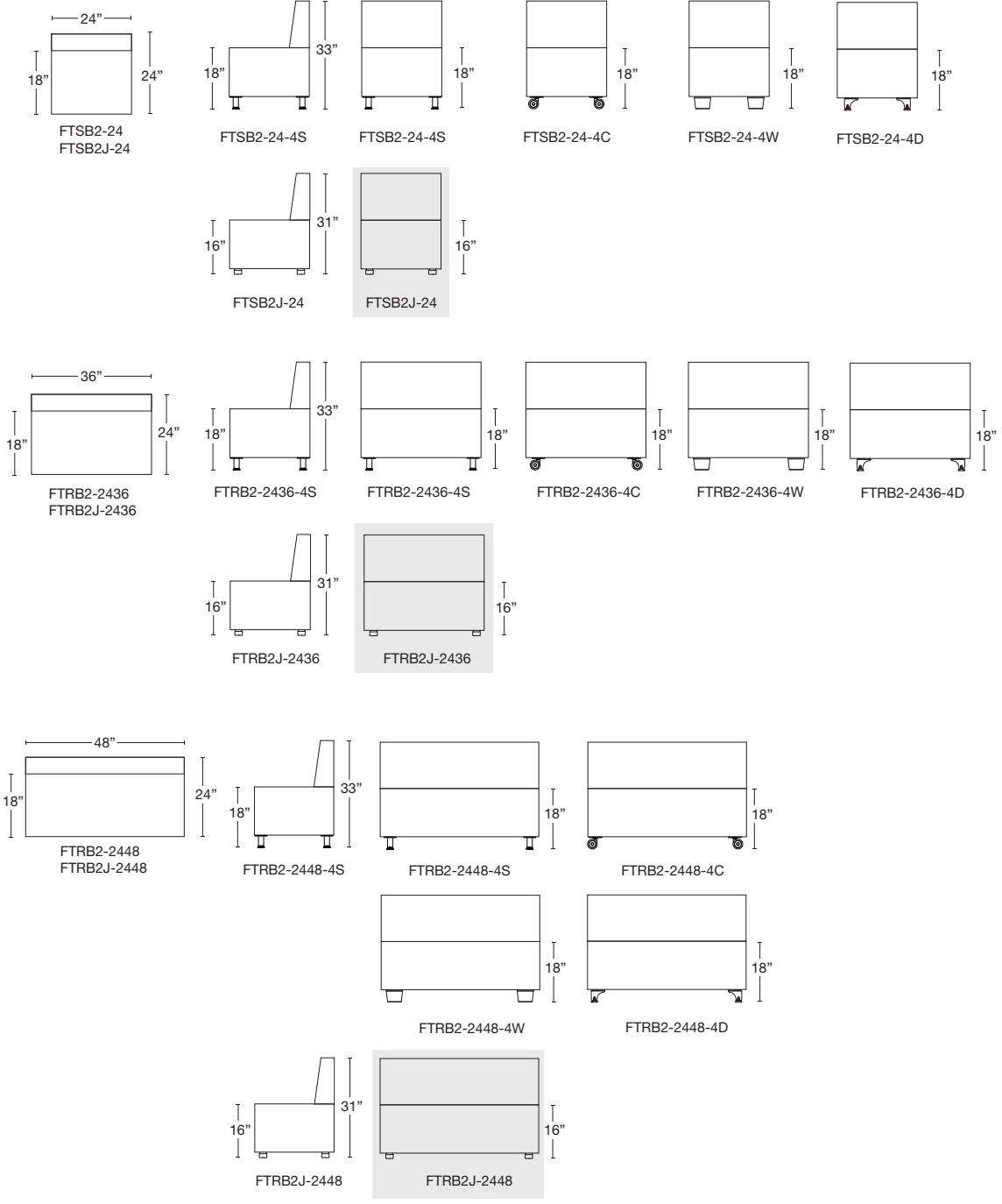
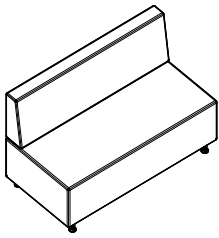

■ = Junior seat height 16"

HALFBACK SQUARE AND RECTANGLE OTTOMANS cont'd

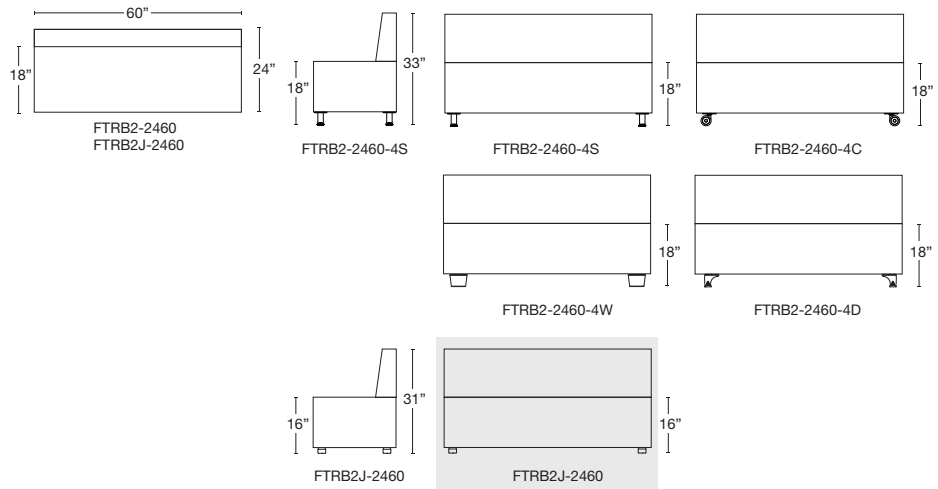
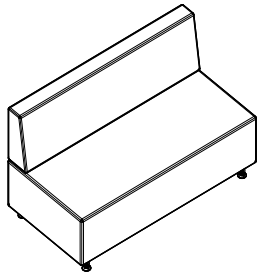

■ = Junior seat height 16"

HALFBACK CURVE OTTOMANS (Concave)

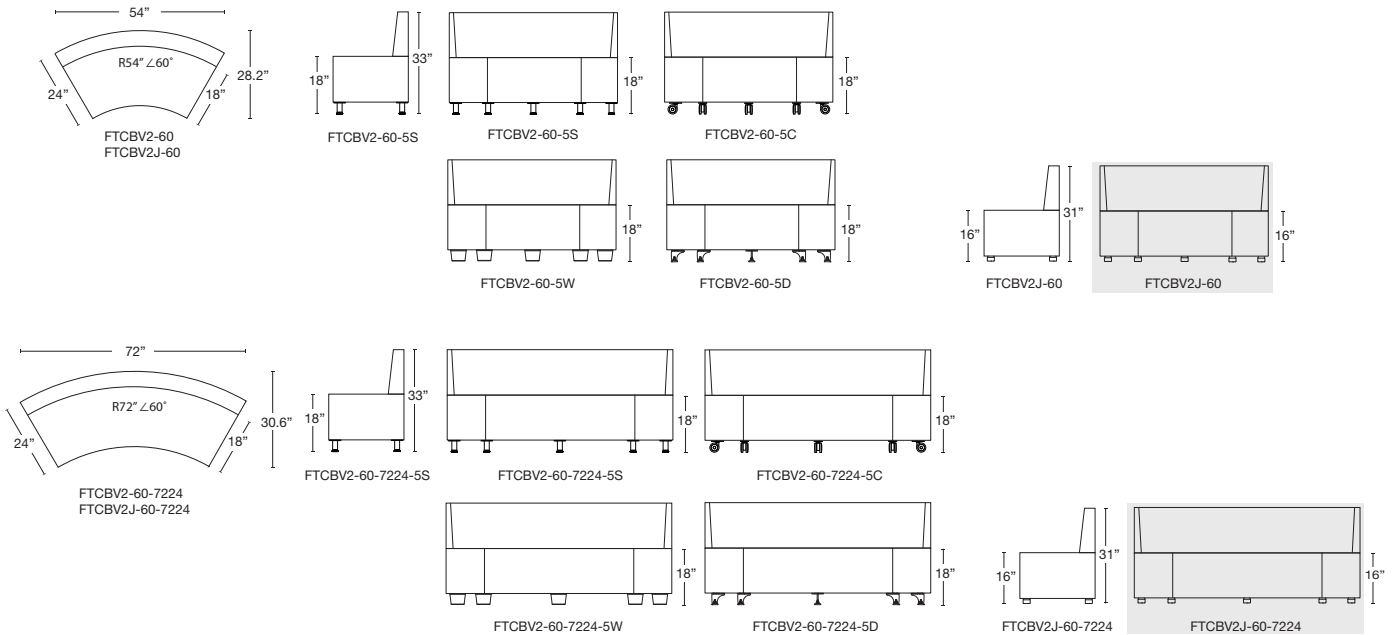
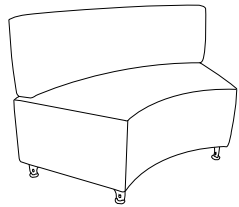

R = Radius in inches
 ∠ = Curve Angle in degrees
 ■ = Junior seat height 16"

HALFBACK CURVE OTTOMANS (Convex)

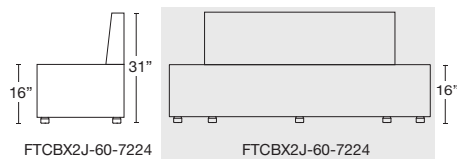
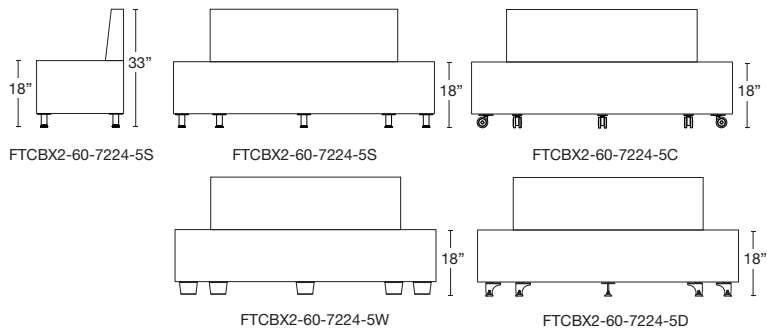
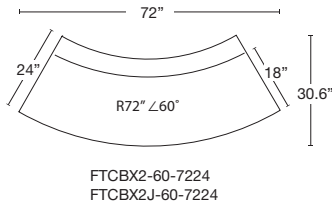
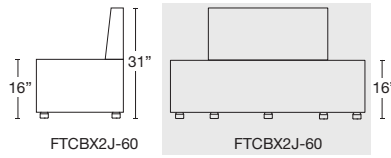
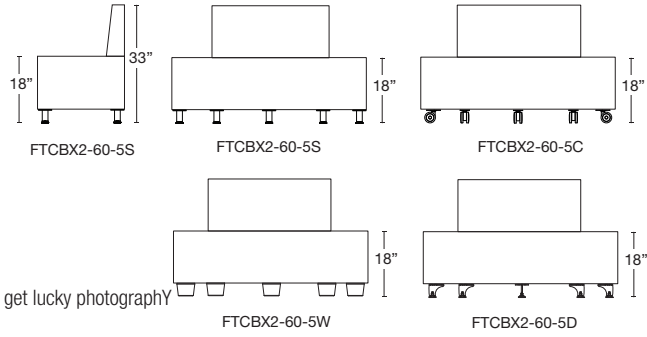
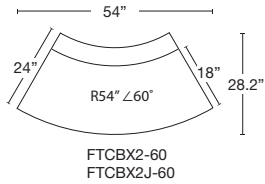
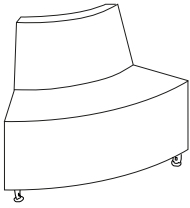

R = Radius in inches
 ∠ = Curve Angle in degrees
 ■ = Junior seat height 16"

QUARTER ROUND HALFBACK (Crescent)

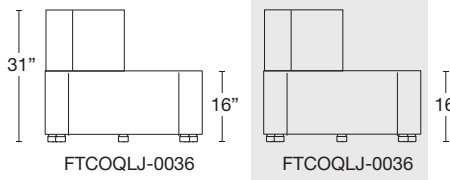
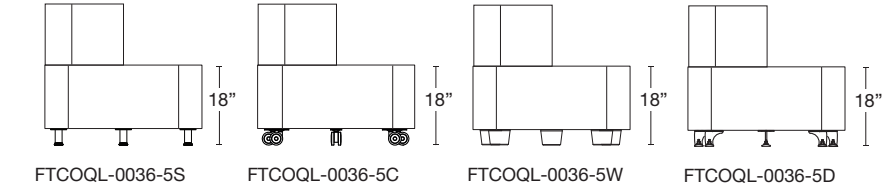
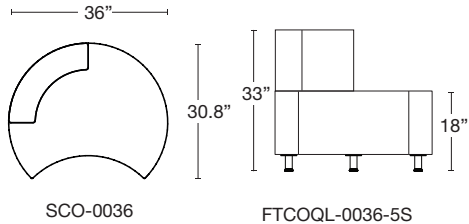
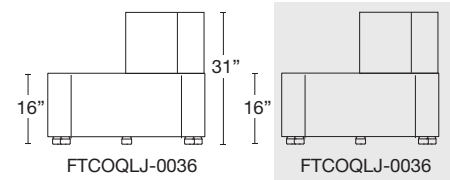
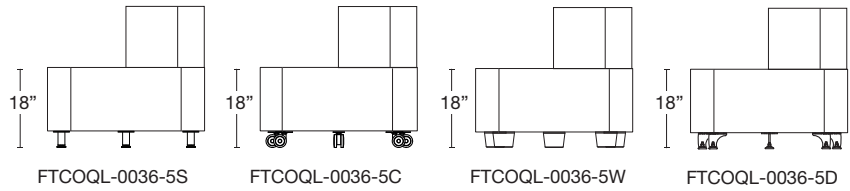
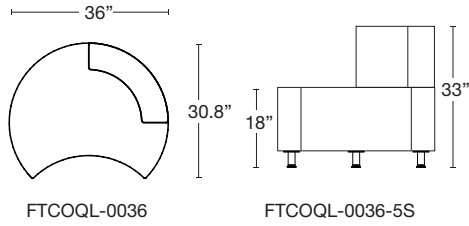
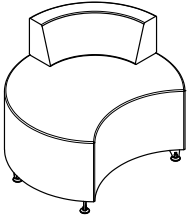

■ = Junior seat height 16"

ROUND OTTABLES

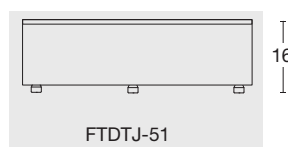
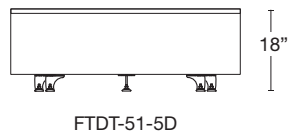
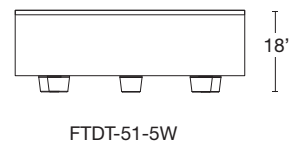
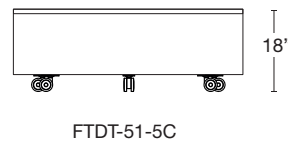
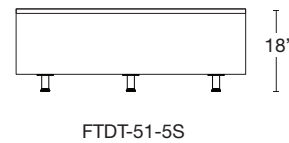
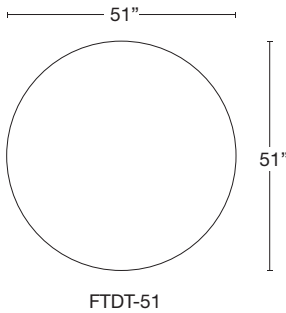
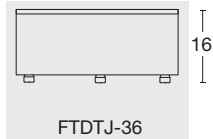
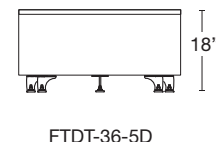
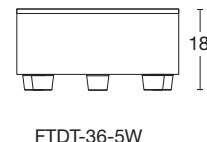
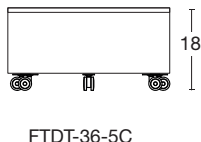
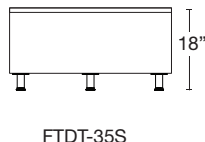
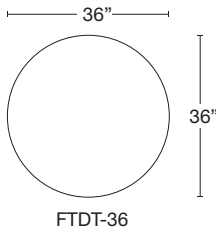
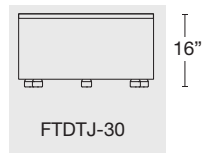
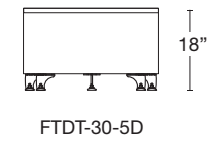
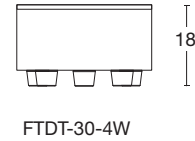
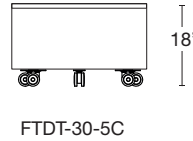
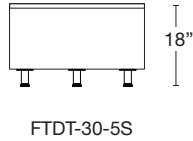
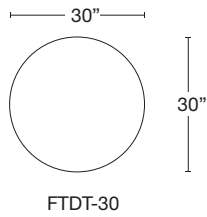
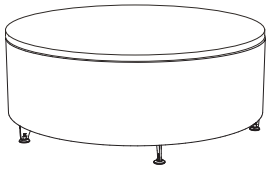

■ = Junior height 16"

RECTANGLE OTTAPLES

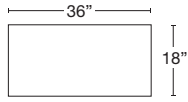
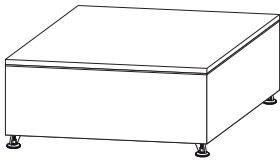

FTRT-1836

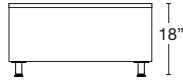

FTRT-1836-4S

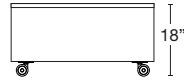

FTRT-1836-4C

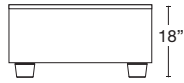

FTRT-1836-4W

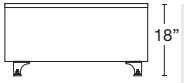

FTRT-1836-4W

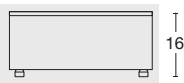

FTRTJ-1836

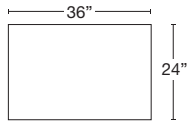

FTRT-2436

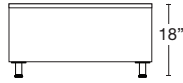

FTRT-2436-4S

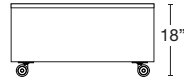

FTRT-2436-4C

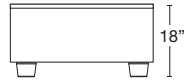

FTRT-2436-4W



FTRT-2436-4D

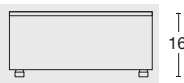

FTRTJ-2436

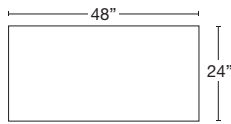

FTRT-2448

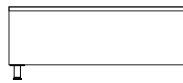

FTRT-2448-4S

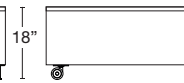

FTRT-2448-4C

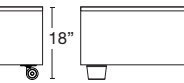

FTRT-2448-4W

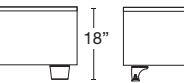

FTRT-2448-4D

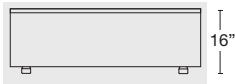

FTRTJ-2448

■ = Junior height 16"

SQUARE OTTAPLES

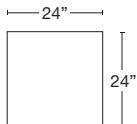
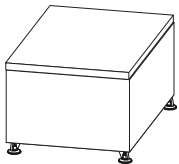

FTST-24

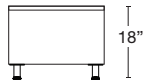

FTST-24-4S

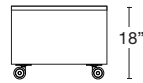

FTST-24-4C

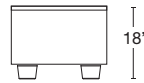

FTST-24-4W

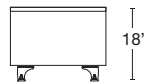

FTST-24-4D

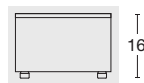

FTSTJ-24

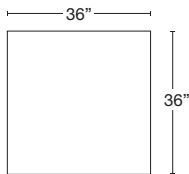

FTST-36



FTST-36-4S

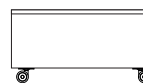

FTST-36-4C

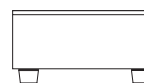

FTST-36-4W

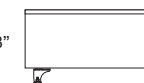

FTST-36-4D



FTSTJ-36

■ = Junior height 16"

Crescents and Rounds

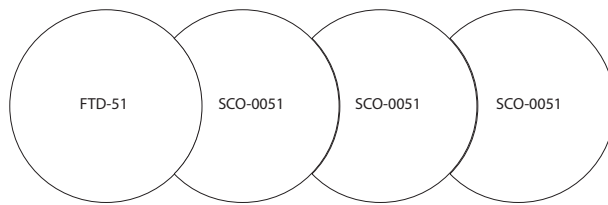
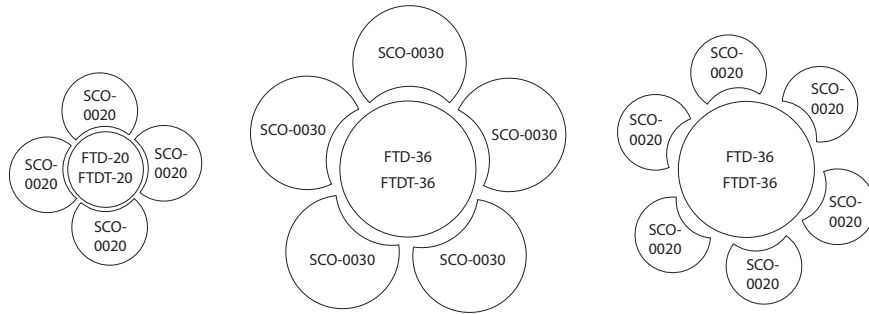

Curves and Rounds

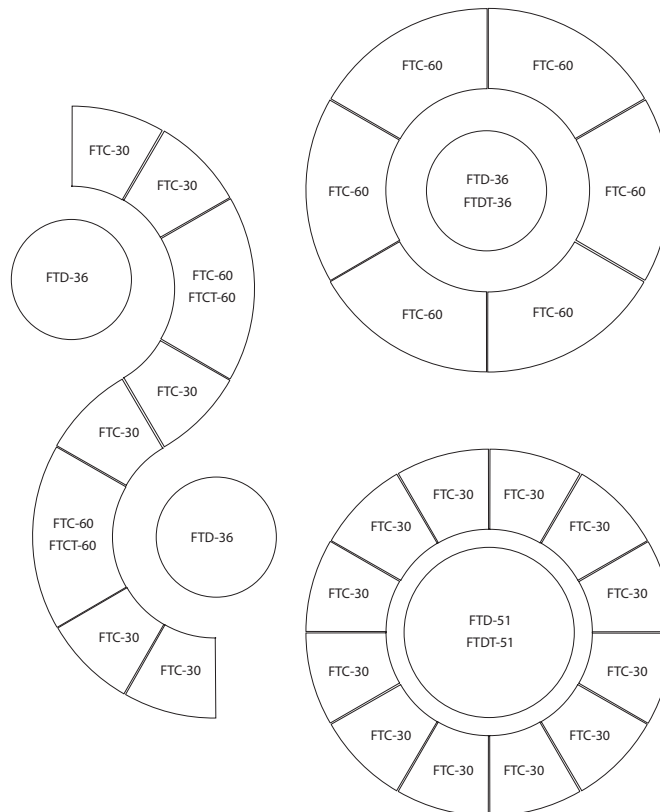

Rectangles, Half-Rounds & Curves

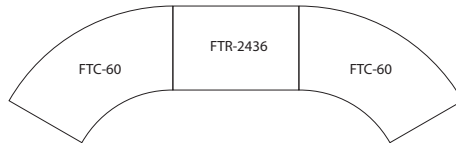
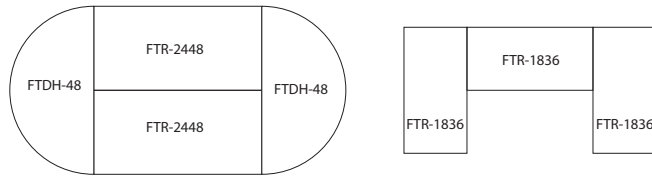

Pentagons

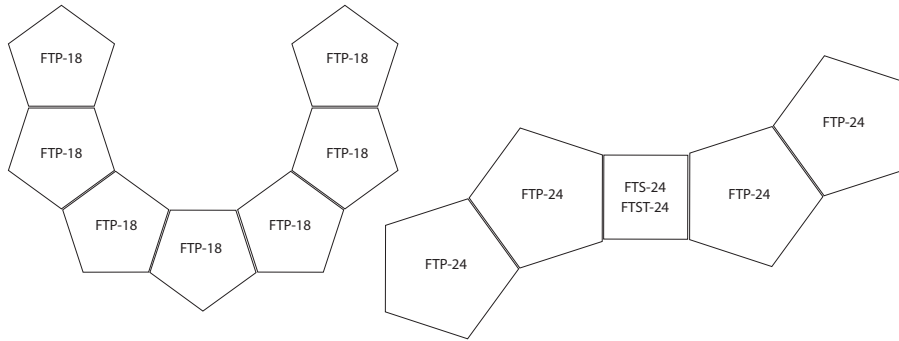

Halfbacks, Ottomans & Ottables

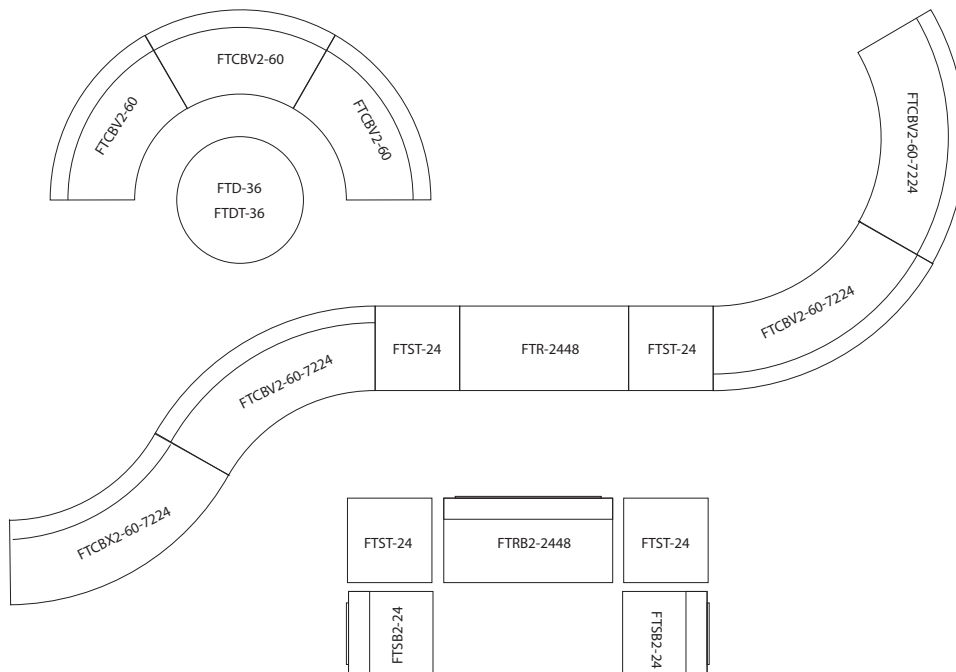

General Specifications

Seat:	Fully upholstered seat. Interior construction consists of a 1" thick structural wood frame wrapped with ½" thick, 2.3# density foam on the sides. Seat basis is 2" of high density foam. Customer specifies upholstery fabric(s).
Steel Legs:	Steel post legs are fabricated from 5/16" powder coated plate steel and include a curved profile with a square mounting plate. The bottom of each leg is fitted with a threaded weld nut and 1-7/8" black leveling glide. Customer specifies powder coat color.
Wood Legs:	Wood legs are 3-1/3" x 3-1/2" hardwood with a 45 degree chamfer at the bottom edge. Wood post legs are attached 5/16"-18 bolt, washer and propeller nut. Wood legs can be finished in any of our standard wood (Oak, Maple or Sprayon) finishes. Customer specifies wood leg finish.
Casters:	Swivel casters are mounted to the base with a square mounting plate. FTD-20 and FTSC-20 models receive (5) 50mm casters, all other models receive (4) or (5) 75mm casters. Casters are black.
Self Leveling Glides: <i>Full Time Junior models</i>	Self-leveling glides are constructed of heavy duty steel, thermoplastic polyurethane and impact resistant nylon. Average installation height is 1-1/8". Glides are black.
Seat Back: <i>Full Time Halfbacks only</i>	Fully upholstered seat back. Seat back is 6" of high density foam at its base and tapers up to 3.5" of foam at the top. The seat back is built on a 1" thick rectangular wooden panel. Seat and seat back are joined by internal posts. Customer specifies upholstery fabric.
Worksurface: <i>Full Time Ottobles only</i>	Work surfaces are 1" thick, with a 7/8" particleboard core, .050" high-pressure laminate top and a .030 or thicker phenolic backer. Edge is 1/8" PVC. Worksurface shape matches the base shape. Customer specifies high pressure laminate work surface and PVC edgeband selections. *Connectivity option available in work surface.
Fabric and Finishes	
Upholstery Choices:	Visit our website for graded fabric selection options. Full Time Ottomans and Full Time Halfbacks offer the option of applying multiple fabrics. For two-fabric applications of different grades, the Grade will default to the highest grade. For example a 2 and 5 will be Graded as a 5.
Powder Coat Choices:	Visit our website for powder coat selection.
Wood Finish Choices:	Visit our website for wood finish selection.
High Pressure Laminate Choices:	Visit our website for high pressure laminate selection.
PVC Edgeband Choices:	Visit our website for PVC edgeband selection.

Electrical and Connectivity

Connectivity for Full Time Ottoman & Full Time Halfback:

Electrical and connectivity panels can only be mounted on Flat vertical surfaces of Full Time Ottomans and Full Time Halfbacks. The following shapes have at least one flat vertical surface where a panel can be mounted:

- Square
- Rectangle
- Pentagon
- Half Round
- Curve

Connectivity Panel Option:

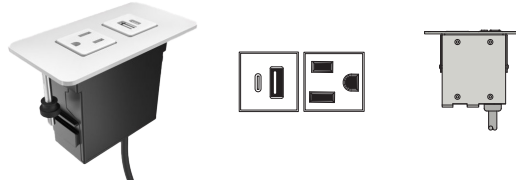

DUET

ADUF-1P1UC-

- In-surface, rectangular panel, face mount, suitable for upholstery.
- 2" x 3.25" cutout
- 3.75" between mounting holes
- 1 AC receptacle and a Dual USB port (2 amps each)
- UL Listed
- 72" and 120" cord lengths
- White, silver and black face plates available
- Default orientaion of panel is horizontal

Connectivity for Full Time Ottables:

The **workspace** of Full Time Ottables can accept any of the "In-Surface" -mount electrical and connectivity accessory devices shown in our "Connect" brochure (www.mediatechnologies.com/resources/downloads/brochures). See the Connect brochure for descriptions, available options and cutout information. These devices include:

- | | |
|-----------|-------------|
| • Envoy | • Powerspot |
| • Port | • Ensemble |
| • Aztech | • Duet |
| • Treo | • Jolt |
| • Dual Up | • Charge Up |



Only **Duet** (see above) connectivity panels can be mounted on **flat vertical** surfaces of Full Time Ottables. The following shapes have at least one flat vertical surface where a panel can be mounted:

- Square
- Rectangle

Ottoman List Price

Round															
Model Number	Base	Seat	Diameter (in.)	Seat Hgt. (in.)	Wgt. (lbs.)	COM Yd.	List Price								
							Grade 1 COM	Grade 2	Grade 3	Grade 4	Grade 5	Grade 6	Grade 7	Grade 8	Grade 9
FTD-20-5S	Steel Post	Uph	20	18	64	1.5	\$1,189	\$1,276	\$1,371	\$1,458	\$1,480	\$1,500	\$1,569	\$1,610	\$1,670
FTD-20-5C	Casters	Uph	20	18	64	1.5	\$1,053	\$1,143	\$1,235	\$1,323	\$1,345	\$1,365	\$1,386	\$1,467	\$1,522
FTD-20-4W	Wood	Uph	20	18	64	1.5	\$1,189	\$1,276	\$1,371	\$1,458	\$1,480	\$1,500	\$1,569	\$1,610	\$1,670
FTD-20-4D	Duo	Uph	20	18	64	1.5	\$1,189	\$1,276	\$1,371	\$1,458	\$1,480	\$1,500	\$1,569	\$1,610	\$1,670
FTD-30-5S	Steel Post	Uph	30	18	84	2.5	\$1,532	\$1,703	\$1,858	\$2,014	\$2,173	\$2,327	\$2,482	\$2,653	\$2,839
FTD-30-5C	Casters	Uph	30	18	84	2.5	\$1,532	\$1,703	\$1,858	\$2,014	\$2,173	\$2,327	\$2,482	\$2,653	\$2,839
FTD-30-5W	Wood	Uph	30	18	84	2.5	\$1,532	\$1,703	\$1,858	\$2,014	\$2,173	\$2,327	\$2,482	\$2,653	\$2,839
FTD-30-5D	Duo	Uph	30	18	84	2.5	\$1,532	\$1,703	\$1,858	\$2,014	\$2,173	\$2,327	\$2,482	\$2,653	\$2,839
FTD-36-5S	Steel Post	Uph	36	18	96	2.5	\$1,698	\$1,891	\$2,064	\$2,236	\$2,411	\$2,583	\$2,758	\$2,775	\$2,876
FTD-36-5C	Casters	Uph	36	18	96	2.5	\$1,698	\$1,891	\$2,064	\$2,236	\$2,411	\$2,583	\$2,758	\$2,775	\$2,876
FTD-36-5W	Wood	Uph	36	18	96	2.5	\$1,698	\$1,891	\$2,064	\$2,236	\$2,411	\$2,583	\$2,758	\$2,775	\$2,876
FTD-36-5D	Duo	Uph	36	18	96	2.5	\$1,698	\$1,891	\$2,064	\$2,236	\$2,411	\$2,583	\$2,758	\$2,775	\$2,876
FTD-51-5S	Steel Post	Uph	51	18	132	3.5	\$2,546	\$2,756	\$2,940	\$3,125	\$3,310	\$3,493	\$3,677	\$3,752	\$3,889
FTD-51-5C	Casters	Uph	51	18	132	3.5	\$2,546	\$2,756	\$2,940	\$3,125	\$3,310	\$3,493	\$3,677	\$3,752	\$3,889
FTD-51-5W	Wood	Uph	51	18	132	3.5	\$2,546	\$2,756	\$2,940	\$3,125	\$3,310	\$3,493	\$3,677	\$3,752	\$3,889
FTD-51-5D	Duo	Uph	51	18	132	3.5	\$2,546	\$2,756	\$2,940	\$3,125	\$3,310	\$3,493	\$3,677	\$3,752	\$3,889
Round Junior															
FTDJ-20	Self-Leveling Glide	Uph	20	16	64	1.5	\$1,129	\$1,212	\$1,302	\$1,385	\$1,406	\$1,425	\$1,490	\$1,529	\$1,586
FTDJ-30	Self-Leveling Glide	Uph	30	16	84	2.5	\$1,455	\$1,617	\$1,765	\$1,913	\$2,064	\$2,210	\$2,357	\$2,520	\$2,697
FTDJ-36	Self-Leveling Glide	Uph	36	16	96	2.5	\$1,613	\$1,796	\$1,960	\$2,124	\$2,290	\$2,453	\$2,620	\$2,636	\$2,732
FTDJ-51	Self-Leveling Glide	Uph	51	16	132	3.5	\$2,418	\$2,618	\$2,793	\$2,968	\$3,144	\$3,318	\$3,493	\$3,564	\$3,694
Crescent															
Model Number	Base	Seat	Diameter (in.)	Seat Hgt. (in.)	Wgt. (lbs.)	COM Yd.	List Price								
							Grade 1 COM	Grade 2	Grade 3	Grade 4	Grade 5	Grade 6	Grade 7	Grade 8	Grade 9
SCO-0020-5S	Steel Post	Uph	20	18	60	1.5	\$1,053	\$1,189	\$1,323	\$1,486	\$1,671	\$1,877	\$1,946	\$2,015	\$2,091
SCO-0020-5C	Casters	Uph	20	18	60	1.5	\$1,053	\$1,189	\$1,323	\$1,486	\$1,671	\$1,877	\$1,946	\$2,015	\$2,091
SCO-0020-5W	Wood	Uph	20	18	60	1.5	\$1,053	\$1,189	\$1,323	\$1,486	\$1,671	\$1,877	\$1,946	\$2,015	\$2,091
SCO-0020-5D	Duo	Uph	20	18	60	1.5	\$1,053	\$1,189	\$1,323	\$1,486	\$1,671	\$1,877	\$1,946	\$2,015	\$2,091
SCO-0030-5S	Steel Post	Uph	30	18	90	2.5	\$1,825	\$1,972	\$2,105	\$2,236	\$2,354	\$2,479	\$2,544	\$2,665	\$2,762
SCO-0030-5C	Casters	Uph	30	18	90	2.5	\$1,825	\$1,972	\$2,105	\$2,236	\$2,354	\$2,479	\$2,544	\$2,665	\$2,762
SCO-0030-5W	Wood	Uph	30	18	90	2.5	\$1,825	\$1,972	\$2,105	\$2,236	\$2,354	\$2,479	\$2,544	\$2,665	\$2,762
SCO-0030-5D	Duo	Uph	30	18	90	2.5	\$1,825	\$1,972	\$2,105	\$2,236	\$2,354	\$2,479	\$2,544	\$2,665	\$2,762
SCO-0036-5S	Steel Post	Uph	36	18	108	2.5	\$2,028	\$2,162	\$2,374	\$2,510	\$2,710	\$2,851	\$2,955	\$3,064	\$3,173
SCO-0036-5C	Casters	Uph	36	18	108	2.5	\$2,028	\$2,162	\$2,374	\$2,510	\$2,710	\$2,851	\$2,955	\$3,064	\$3,173
SCO-0036-5W	Wood	Uph	36	18	108	2.5	\$2,028	\$2,162	\$2,374	\$2,510	\$2,710	\$2,851	\$2,955	\$3,064	\$3,173
SCO-0036-5D	Duo	Uph	36	18	108	2.5	\$2,028	\$2,162	\$2,374	\$2,510	\$2,710	\$2,851	\$2,955	\$3,064	\$3,173
SCO-0051-5S	Steel Post	Uph	51	18	121	3.5	\$2,546	\$2,756	\$2,940	\$3,125	\$3,310	\$3,493	\$3,620	\$3,752	\$3,889
SCO-0051-5C	Casters	Uph	51	18	121	3.5	\$2,546	\$2,756	\$2,940	\$3,125	\$3,310	\$3,493	\$3,620	\$3,752	\$3,889
SCO-0051-5W	Wood	Uph	51	18	121	3.5	\$2,546	\$2,756	\$2,940	\$3,125	\$3,310	\$3,493	\$3,620	\$3,752	\$3,889
SCO-0051-5D	Duo	Uph	51	18	121	3.5	\$2,546	\$2,756	\$2,940	\$3,125	\$3,310	\$3,493	\$3,620	\$3,752	\$3,889
Crescent Junior															
FTCOJ-0020	Self-Leveling Glide	Uph	20	16	60	1.5	\$1,053	\$1,189	\$1,323	\$1,486	\$1,671	\$1,877	\$1,946	\$2,015	\$2,091
FTCOJ-0030	Self-Leveling Glide	Uph	30	16	90	2.5	\$1,825	\$1,972	\$2,105	\$2,236	\$2,354	\$2,479	\$2,544	\$2,665	\$2,762
FTCOJ-0036	Self-Leveling Glide	Uph	36	16	108	2.5	\$2,028	\$2,162	\$2,374	\$2,510	\$2,710	\$2,851	\$2,955	\$3,064	\$3,173
FTCOJ-0051	Self-Leveling Glide	Uph	51	16	121	3.5	\$2,546	\$2,756	\$2,940	\$3,125	\$3,310	\$3,493	\$3,620	\$3,752	\$3,889

P-TIMESERIES-240114



Ottoman List Price

Half Round																
Model Number	Base	Seat	Depth (in.)	Width (in.)	Seat Hgt. (in.)	Wgt. (lbs.)	COM Yd.	List Price								
								Grade 1 COM	Grade 2	Grade 3	Grade 4	Grade 5	Grade 6	Grade 7	Grade 8	Grade 9
FTHD-48-4S	Steel Post	Uph	24	48"	18	66	2.5	\$2,544	\$2,651	\$2,764	\$2,878	\$2,998	\$3,124	\$3,238	\$3,357	\$3,477
FTHD-48-4C	Casters	Uph	24	48"	18	66	2.5	\$2,544	\$2,651	\$2,764	\$2,878	\$2,998	\$3,124	\$3,238	\$3,357	\$3,477
FTHD-48-4W	Wood	Uph	24	48"	18	66	2.5	\$2,544	\$2,651	\$2,764	\$2,878	\$2,998	\$3,124	\$3,238	\$3,357	\$3,477
FTHD-48-4D	Duo	Uph	24	48"	18	66	2.5	\$2,544	\$2,651	\$2,764	\$2,878	\$2,998	\$3,124	\$3,238	\$3,357	\$3,477
Half Round Junior																
FTHDJ-48	Self-Leveling Glide	Uph	24	48"	16	66	2.5	\$2,544	\$2,651	\$2,764	\$2,878	\$2,998	\$3,124	\$3,238	\$3,357	\$3,477
Curve																
Model Number	Base	Seat	Return Depth (in.)	Width (in.)	Seat Hgt. (in.)	Wgt. (lbs.)	COM Yd.	List Price								
								Grade 1 COM	Grade 2	Grade 3	Grade 4	Grade 5	Grade 6	Grade 7	Grade 8	Grade 9
FTC-30-4S	Steel Post	Uph	24	28	18	69	1.5	\$1,374	\$1,466	\$1,546	\$1,624	\$1,700	\$1,780	\$1,973	\$2,048	\$2,124
FTC-30-4C	Casters	Uph	24	28	18	69	1.5	\$1,374	\$1,466	\$1,546	\$1,624	\$1,700	\$1,780	\$1,973	\$2,048	\$2,124
FTC-30-4W	Wood	Uph	24	28	18	69	1.5	\$1,374	\$1,466	\$1,546	\$1,624	\$1,700	\$1,780	\$1,973	\$2,048	\$2,124
FTC-30-4D	Duo	Uph	24	28	18	69	1.5	\$1,374	\$1,466	\$1,546	\$1,624	\$1,700	\$1,780	\$1,973	\$2,048	\$2,124
FTC-60-4S	Steel Post	Uph	24	54	18	140	3	\$2,400	\$2,499	\$2,604	\$2,713	\$2,828	\$2,944	\$3,230	\$3,351	\$3,474
FTC-60-5C	Casters	Uph	24	54	18	140	3	\$2,400	\$2,499	\$2,604	\$2,713	\$2,828	\$2,944	\$3,230	\$3,351	\$3,474
FTC-60-5W	Wood	Uph	24	54	18	140	3	\$2,400	\$2,499	\$2,604	\$2,713	\$2,828	\$2,944	\$3,230	\$3,351	\$3,474
FTC-60-5D	Duo	Uph	24	54	18	140	3	\$2,400	\$2,499	\$2,604	\$2,713	\$2,828	\$2,944	\$3,230	\$3,351	\$3,474
FTC-30-7224-4S	Steel Post	Uph	24	37.25	18	84	2	\$1,725	\$1,798	\$1,951	\$2,033	\$2,116	\$2,206	\$2,298	\$2,370	\$2,456
FTC-30-7224-4C	Casters	Uph	24	37.25	18	84	2	\$1,725	\$1,798	\$1,951	\$2,033	\$2,116	\$2,206	\$2,298	\$2,370	\$2,456
FTC-30-7224-4W	Wood	Uph	24	37.25	18	84	2	\$1,725	\$1,798	\$1,951	\$2,033	\$2,116	\$2,206	\$2,298	\$2,370	\$2,456
FTC-30-7224-4D	Duo	Uph	24	37.25	18	84	2	\$1,725	\$1,798	\$1,951	\$2,033	\$2,116	\$2,206	\$2,298	\$2,370	\$2,456
FTC-60-4221-DVS-5S	Steel Post	Uph	21"	41.75"	18	85	2	\$1,646	\$1,713	\$1,784	\$1,857	\$1,936	\$2,017	\$2,103	\$2,180	\$2,258
FTC-60-4221-DVS-5C	Casters	Uph	21"	41.75"	18	85	2	\$1,646	\$1,713	\$1,784	\$1,857	\$1,936	\$2,017	\$2,103	\$2,180	\$2,258
FTC-60-4221-DVS-5W	Wood	Uph	21"	41.75"	18	85	2	\$1,646	\$1,713	\$1,784	\$1,857	\$1,936	\$2,017	\$2,103	\$2,180	\$2,258
FTC-60-4221-DVS-5D	Duo	Uph	21"	41.75"	18	85	2	\$1,646	\$1,713	\$1,784	\$1,857	\$1,936	\$2,017	\$2,103	\$2,180	\$2,258
FTCJ-30	Self-Leveling Glide	Uph	24	28	16	69	1.5	\$1,374	\$1,466	\$1,546	\$1,624	\$1,700	\$1,780	\$1,973	\$2,048	\$2,124
FTCJ-60	Self-Leveling Glide	Uph	24	54	16	140	3	\$2,400	\$2,499	\$2,604	\$2,713	\$2,828	\$2,944	\$3,230	\$3,351	\$3,474
FTCJ-30-7224	Self-Leveling Glide	Uph	24	37.25	16	84	2	\$1,725	\$1,798	\$1,951	\$2,033	\$2,116	\$2,206	\$2,298	\$2,370	\$2,456
FTCJ-60-4221-DVS	Self-Leveling Glide	Uph	21"	41.75"	16	85	2	\$1,646	\$1,713	\$1,784	\$1,857	\$1,936	\$2,017	\$2,103	\$2,180	\$2,258
FTCJ-60-4221-18-DVS	Self-Leveling Glide	Uph	21"	41.75"	18	85	2	\$1,646	\$1,713	\$1,784	\$1,857	\$1,936	\$2,017	\$2,103	\$2,180	\$2,258
Hexagon																
Model Number	Base	Seat	Depth (in.)	Width (in.)	Seat Hgt. (in.)	Wgt. (lbs.)	COM Yd.	List Price								
								Grade 1 COM	Grade 2	Grade 3	Grade 4	Grade 5	Grade 6	Grade 7	Grade 8	Grade 9
FTX-20-6S	Steel Post	Uph	20	20	18		1.25	\$1,083	\$1,136	\$1,193	\$1,245	\$1,285	\$1,327	\$1,358	\$1,390	\$1,422
FTX-20-6C	Casters	Uph	20	20	18		1.25	\$1,083	\$1,136	\$1,193	\$1,245	\$1,285	\$1,327	\$1,358	\$1,390	\$1,422
FTX-20-6W	Wood	Uph	20	20	18		1.25	\$1,083	\$1,136	\$1,193	\$1,245	\$1,285	\$1,327	\$1,358	\$1,390	\$1,422
FTX-20-6D	Duo	Uph	20	20	18		1.25	\$1,083	\$1,136	\$1,193	\$1,245	\$1,285	\$1,327	\$1,358	\$1,390	\$1,422
Hexagon Junior																
FTXJ-20	Self-Leveling Glide	Uph	20	20	16		998	\$1,051	\$1,105	\$1,162	\$1,213	\$1,253	\$1,295	\$1,327	\$1,358	\$1,390

Pentagon																
Model Number	Base	Seat	Depth (in.)	Width (in.)	Seat Hgt. (in.)	Wgt. (lbs.)	COM Yd.	List Price								
								Grade 1 COM	Grade 2	Grade 3	Grade 4	Grade 5	Grade 6	Grade 7	Grade 8	Grade 9
FTP-18-5S	Steel Post	Uph	28	30	18	63	1.75	\$1,653	\$1,758	\$1,850	\$1,945	\$2,036	\$2,132	\$2,208	\$2,290	\$2,374
FTP-18-5C	Casters	Uph	28	30	18	63	1.75	\$1,653	\$1,758	\$1,850	\$1,945	\$2,036	\$2,132	\$2,208	\$2,290	\$2,374
FTP-18-5W	Wood	Uph	28	30	18	63	1.75	\$1,653	\$1,758	\$1,850	\$1,945	\$2,036	\$2,132	\$2,208	\$2,290	\$2,374
FTP-18-5D	Duo	Uph	28	30	18	63	1.75	\$1,653	\$1,758	\$1,850	\$1,945	\$2,036	\$2,132	\$2,208	\$2,290	\$2,374
FTP-24-5S	Steel Post	Uph	37"	39"	18	84	2.5	\$1,899	\$2,048	\$2,180	\$2,313	\$2,445	\$2,578	\$2,671	\$2,769	\$2,870
FTP-24-5C	Casters	Uph	37"	39"	18	84	2.5	\$1,899	\$2,048	\$2,180	\$2,313	\$2,445	\$2,578	\$2,671	\$2,769	\$2,870
FTP-24-5W	Wood	Uph	37"	39"	18	84	2.5	\$1,899	\$2,048	\$2,180	\$2,313	\$2,445	\$2,578	\$2,671	\$2,769	\$2,870
FTP-24-5D	Duo	Uph	37"	39"	18	84	2.5	\$1,899	\$2,048	\$2,180	\$2,313	\$2,445	\$2,578	\$2,671	\$2,769	\$2,870

Pentagon Junior																
FTPJ-18	Self-Leveling Glide	Uph	28	30	16	63	1.75	\$1,653	\$1,758	\$1,850	\$1,945	\$2,036	\$2,132	\$2,208	\$2,290	\$2,374
FTPJ-24	Self-Leveling Glide	Uph	37"	39"	16	84	2.5	\$1,899	\$2,048	\$2,180	\$2,313	\$2,445	\$2,578	\$2,671	\$2,769	\$2,870

Square																
Model Number	Base	Seat	Depth (in.)	Width (in.)	Seat Hgt. (in.)	Wgt. (lbs.)	COM Yd.	List Price								
								Grade 1 COM	Grade 2	Grade 3	Grade 4	Grade 5	Grade 6	Grade 7	Grade 8	Grade 9
FTS-2424-4S	Steel Post	Uph	24	24	18	60	1.75	\$1,397	\$1,460	\$1,534	\$1,606	\$1,680	\$1,759	\$1,885	\$1,956	\$2,031
FTS-2424-4C	Casters	Uph	24	24	18	60	1.75	\$1,397	\$1,460	\$1,534	\$1,606	\$1,680	\$1,759	\$1,885	\$1,956	\$2,031
FTS-2424-4W	Wood	Uph	24	24	18	60	1.75	\$1,397	\$1,460	\$1,534	\$1,606	\$1,680	\$1,759	\$1,885	\$1,956	\$2,031
FTS-2424-4D	Duo leg	Uph	24	24	18	60	1.75	\$1,397	\$1,460	\$1,534	\$1,606	\$1,680	\$1,759	\$1,885	\$1,956	\$2,031
FTS-3636-4S	Steel Post	Uph	36	36	18	89	2.25	\$1,513	\$1,650	\$1,767	\$1,887	\$2,006	\$2,124	\$2,203	\$2,283	\$2,367
FTS-3636-4C	Casters	Uph	36	36	18	89	2.25	\$1,513	\$1,650	\$1,767	\$1,887	\$2,006	\$2,124	\$2,203	\$2,283	\$2,367
FTS-3636-4W	Wood	Uph	36	36	18	89	2.25	\$1,513	\$1,650	\$1,767	\$1,887	\$2,006	\$2,124	\$2,203	\$2,283	\$2,367
FTS-3636-4D	Duo leg	Uph	36	36	18	89	2.25	\$1,513	\$1,650	\$1,767	\$1,887	\$2,006	\$2,124	\$2,203	\$2,283	\$2,367
FTS-4040-4S	Steel post	uph	40	40	18	105	2.75	\$1,679	\$1,831	\$1,962	\$2,094	\$2,227	\$2,357	\$2,445	\$2,533	\$2,732
FTS-4040-4C	Casters	uph	40	40	18	105	2.75	\$1,679	\$1,831	\$1,962	\$2,094	\$2,227	\$2,357	\$2,445	\$2,533	\$2,732
FTS-4040-4W	Wood	uph	40	40	18	105	2.75	\$1,679	\$1,831	\$1,962	\$2,094	\$2,227	\$2,357	\$2,445	\$2,533	\$2,732
FTS-4040-4D	Duo leg	uph	40	40	18	105	2.75	\$1,679	\$1,831	\$1,962	\$2,094	\$2,227	\$2,357	\$2,445	\$2,533	\$2,732

Square Junior																
FTSJ-2424	Self-Leveling Glide	Uph	24	24	16	60	1.75	\$1,397	\$1,460	\$1,534	\$1,606	\$1,680	\$1,759	\$1,885	\$1,956	\$2,031
FTSJ-3636	Self-Leveling Glide	Uph	36	36	16	89	2.25	\$1,513	\$1,650	\$1,767	\$1,887	\$2,006	\$2,124	\$2,203	\$2,283	\$2,367
FTSJ-4040	Self-Leveling Glide	Uph	40	40	16	105	2.75	\$1,679	\$1,831	\$1,962	\$2,094	\$2,227	\$2,357	\$2,445	\$2,533	\$2,732

Ottoman List Price

Rectangle																
Model Number	Base	Seat	Depth (in.)	Width (in.)	Seat Hgt. (in.)	Wgt. (lbs.)	COM Yd.	List Price								
								Grade 1 COM	Grade 2	Grade 3	Grade 4	Grade 5	Grade 6	Grade 7	Grade 8	Grade 9
FTR-1836-4S	Steel Post	Uph	18	36	18	55	1.75	\$1,395	\$1,459	\$1,533	\$1,626	\$1,715	\$1,808	\$1,902	\$1,945	\$2,014
FTR-1836-4C	Casters	Uph	18	36	18	55	1.75	\$1,395	\$1,459	\$1,533	\$1,626	\$1,715	\$1,808	\$1,902	\$1,945	\$2,014
FTR-1836-4W	Wood	Uph	18	36	18	55	1.75	\$1,395	\$1,459	\$1,533	\$1,626	\$1,715	\$1,808	\$1,902	\$1,945	\$2,014
FTR-1836-4D	Duo	Uph	18	36	18	55	1.75	\$1,395	\$1,459	\$1,533	\$1,626	\$1,715	\$1,808	\$1,902	\$1,945	\$2,014
FTR-2436-4S	Steel Post	Uph	24	36	18	72	1.75	\$1,429	\$1,500	\$1,592	\$1,685	\$1,808	\$1,873	\$1,954	\$2,017	\$2,087
FTR-2436-4C	Casters	Uph	24	36	18	72	1.75	\$1,429	\$1,500	\$1,592	\$1,685	\$1,808	\$1,873	\$1,954	\$2,017	\$2,087
FTR-2436-4W	Wood	Uph	24	36	18	72	1.75	\$1,429	\$1,500	\$1,592	\$1,685	\$1,808	\$1,873	\$1,954	\$2,017	\$2,087
FTR-2436-4D	Duo	Uph	24	36	18	72	1.75	\$1,429	\$1,500	\$1,592	\$1,685	\$1,808	\$1,873	\$1,954	\$2,017	\$2,087
FTR-2448-4S	Steel Post	Uph	24	48"	18	80	2	\$1,762	\$1,836	\$1,911	\$1,991	\$2,075	\$2,160	\$2,239	\$2,327	\$2,408
FTR-2448-4C	Casters	Uph	24	48"	18	80	2	\$1,762	\$1,836	\$1,911	\$1,991	\$2,075	\$2,160	\$2,239	\$2,327	\$2,408
FTR-2448-4W	Wood	Uph	24	48"	18	80	2	\$1,762	\$1,836	\$1,911	\$1,991	\$2,075	\$2,160	\$2,239	\$2,327	\$2,408
FTR-2448-4D	Duo	Uph	24	48"	18	80	2	\$1,762	\$1,836	\$1,911	\$1,991	\$2,075	\$2,160	\$2,239	\$2,327	\$2,408
Rectangle Junior																
FTRJ-1836	Self-Leveling Glide	Uph	18	36	16	55	1.75	\$1,395	\$1,459	\$1,533	\$1,626	\$1,715	\$1,808	\$1,902	\$1,945	\$2,014
FTRJ-2436	Self-Leveling Glide	Uph	24	36	16	72	1.75	\$1,429	\$1,500	\$1,592	\$1,685	\$1,808	\$1,873	\$1,954	\$2,017	\$2,087
FTRJ-2448	Self-Leveling Glide	Uph	24	48"	16	80	2	\$1,762	\$1,836	\$1,911	\$1,991	\$2,075	\$2,160	\$2,239	\$2,327	\$2,408
Game Controller																
Model Number	Base	Seat	Depth (in.)	Width (in.)	Seat Hgt. (in.)	Wgt. (lbs.)	COM Yd.	List Price								
								Grade 1 COM	Grade 2	Grade 3	Grade 4	Grade 5	Grade 6	Grade 7	Grade 8	Grade 9
FTGC-2228-4S	Steel Post	Uph	22	28	18	55	1.75	\$1,316	\$1,429	\$1,545	\$1,653	\$1,682	\$1,706	\$1,732	\$1,834	\$1,903
FTGC-2228-4C	Casters	Uph	22	28	18	55	1.75	\$1,316	\$1,429	\$1,545	\$1,653	\$1,682	\$1,706	\$1,732	\$1,834	\$1,903
FTGC-2228-4W	Wood	Uph	22	28	18	55	1.75	\$1,316	\$1,429	\$1,545	\$1,653	\$1,682	\$1,706	\$1,732	\$1,834	\$1,903
FTGC-2228-4D	Duo	Uph	22	28	18	55	1.75	\$1,316	\$1,429	\$1,545	\$1,653	\$1,682	\$1,706	\$1,732	\$1,834	\$1,903
FTGC-3245-4S	Steel Post	Uph	32	46	18	90	2.5	\$1,930	\$2,149	\$2,346	\$2,542	\$2,740	\$2,935	\$3,135	\$3,154	\$3,269
FTGC-3245-4C	Casters	Uph	32	46	18	90	2.5	\$1,930	\$2,149	\$2,346	\$2,542	\$2,740	\$2,935	\$3,135	\$3,154	\$3,269
FTGC-3245-4W	Wood	Uph	32	46	18	90	2.5	\$1,930	\$2,149	\$2,346	\$2,542	\$2,740	\$2,935	\$3,135	\$3,154	\$3,269
FTGC-3245-4D	Duo	Uph	32	46	18	90	2.5	\$1,930	\$2,149	\$2,346	\$2,542	\$2,740	\$2,935	\$3,135	\$3,154	\$3,269
FTGC-3660-5S	Steel Post	Uph	36	60	18	165	3	\$2,893	\$3,132	\$3,342	\$3,551	\$3,762	\$3,970	\$4,179	\$4,264	\$4,419
FTGC-3660-5C	Casters	Uph	36	60	18	165	3	\$2,893	\$3,132	\$3,342	\$3,551	\$3,762	\$3,970	\$4,179	\$4,264	\$4,419
FTGC-3660-5W	Wood	Uph	36	60	18	165	3	\$2,893	\$3,132	\$3,342	\$3,551	\$3,762	\$3,970	\$4,179	\$4,264	\$4,419
FTGC-3660-5D	Duo	Uph	36	60	18	165	3	\$2,893	\$3,132	\$3,342	\$3,551	\$3,762	\$3,970	\$4,179	\$4,264	\$4,419
Game Controller Junior																
FTGCJ-2228	Self-Leveling Glide	Uph	22	28	16	55	1.75	\$1,316	\$1,429	\$1,545	\$1,653	\$1,682	\$1,706	\$1,732	\$1,834	\$1,903
FTGCJ-3245	Self-Leveling Glide	Uph	32	46	16	90	2.5	\$1,930	\$2,149	\$2,346	\$2,542	\$2,740	\$2,935	\$3,135	\$3,154	\$3,269
FTGCJ-3660	Self-Leveling Glide	Uph	36	60	16	165	3	\$2,893	\$3,132	\$3,342	\$3,551	\$3,762	\$3,970	\$4,179	\$4,264	\$4,419

Halfback & Halfback Curve List Price

Halfback Square																	
Model Number	Base	Seat & Back	Depth (in.)	Width (in.)	Seat Hgt. (in.)	Overall Height (in.)	Wgt. (lbs.)	COM Yd.	List Price								
									Grade 1 COM	Grade 2	Grade 3	Grade 4	Grade 5	Grade 6	Grade 7	Grade 8	Grade 9
FTSB2-2424-4S	Steel Post	Uph	24	24	18	33	55	2.5	\$2,298	\$2,368	\$2,418	\$2,483	\$2,548	\$2,613	\$2,710	\$2,809	\$2,911
FTSB2-2424-4C	Casters	Uph	24	24	18	33	55	2.5	\$2,298	\$2,368	\$2,418	\$2,483	\$2,548	\$2,613	\$2,710	\$2,809	\$2,911
FTSB2-2424-4W	Wood	Uph	24	24	18	33	55	2.5	\$2,298	\$2,368	\$2,418	\$2,483	\$2,548	\$2,613	\$2,710	\$2,809	\$2,911
FTSB2-2424-4D	Duo	Uph	24	24	18	33	55	2.5	\$2,298	\$2,368	\$2,418	\$2,483	\$2,548	\$2,613	\$2,710	\$2,809	\$2,911

Halfback Square Junior																	
FTSB2J-2424	Self-leveling Glide	Uph	24	24	16	31	55	2.5	\$2,298	\$2,368	\$2,418	\$2,483	\$2,548	\$2,613	\$2,710	\$2,809	\$2,911

Halfback Square Corner																	
Model Number	Base	Seat & Back	Depth (in.)	Width (in.)	Seat Hgt. (in.)	Overall Height (in.)	Wgt. (lbs.)	COM Yd.	List Price								
									Grade 1 COM	Grade 2	Grade 3	Grade 4	Grade 5	Grade 6	Grade 7	Grade 8	Grade 9
FTSB2C-2424-4S	Steel post	Uph	24	24	18	33	65	3	\$2,553	\$2,630	\$2,687	\$2,758	\$2,831	\$2,903	\$3,011	\$3,120	\$3,234
FTSB2C-2424-4C	Casters	Uph	24	24	18	33	65	3	\$2,553	\$2,630	\$2,687	\$2,758	\$2,831	\$2,903	\$3,011	\$3,120	\$3,234
FTSB2C-2424-4W	Wood	Uph	24	24	18	33	65	3	\$2,553	\$2,630	\$2,687	\$2,758	\$2,831	\$2,903	\$3,011	\$3,120	\$3,234
FTSB2C-2424-4D	Duo	Uph	24	24	18	33	65	3	\$2,553	\$2,630	\$2,687	\$2,758	\$2,831	\$2,903	\$3,011	\$3,120	\$3,234

Halfback Square Corner Junior																	
FTSB2CJ-2424	Self-leveling glide	Uph	24	24	16	31	65	3	\$2,553	\$2,630	\$2,687	\$2,758	\$2,831	\$2,903	\$3,011	\$3,120	\$3,234

Halfback Rectangle																	
Model Number	Base	Seat	Depth	Width	Seat Hgt.	Overall Height	Wgt. (lbs.)	COM Yd.	List Price								
									Grade 1 COM	Grade 2	Grade 3	Grade 4	Grade 5	Grade 6	Grade 7	Grade 8	Grade 9
FTRB2-2436-4S	Steel Post	Uph	24	36	18	33	55	3.25	\$3,457	\$3,563	\$3,635	\$3,737	\$3,835	\$3,934	\$4,075	\$4,224	\$4,378
FTRB2-2436-4C	Casters	Uph	24	36	18	33	55	3.25	\$3,457	\$3,563	\$3,635	\$3,737	\$3,835	\$3,934	\$4,075	\$4,224	\$4,378
FTRB2-2436-4W	Wood	Uph	24	36	18	33	55	3.25	\$3,457	\$3,563	\$3,635	\$3,737	\$3,835	\$3,934	\$4,075	\$4,224	\$4,378
FTRB2-2436-4D	Duo	Uph	24	36	18	33	55	3.25	\$3,457	\$3,563	\$3,635	\$3,737	\$3,835	\$3,934	\$4,075	\$4,224	\$4,378
FTRB2-2448-4S	Steel Post	Uph	24	48	18	33	75	4	\$3,457	\$3,563	\$3,635	\$3,737	\$3,835	\$3,934	\$4,075	\$4,224	\$4,378
FTRB2-2448-4C	Casters	Uph	24	48	18	33	75	4	\$3,457	\$3,563	\$3,635	\$3,737	\$3,835	\$3,934	\$4,075	\$4,224	\$4,378
FTRB2-2448-4W	Wood	Uph	24	48	18	33	75	4	\$3,457	\$3,563	\$3,635	\$3,737	\$3,835	\$3,934	\$4,075	\$4,224	\$4,378
FTRB2-2448-4D	Duo	Uph	24	48	18	33	75	4	\$3,457	\$3,563	\$3,635	\$3,737	\$3,835	\$3,934	\$4,075	\$4,224	\$4,378
FTRB2-2460-4S	Steel Post	Uph	24	60	18	33	100	5	\$3,505	\$3,670	\$3,842	\$4,022	\$4,211	\$4,408	\$4,569	\$4,734	\$4,908
FTRB2-2460-4C	Casters	Uph	24	60	18	33	100	5	\$3,505	\$3,670	\$3,842	\$4,022	\$4,211	\$4,408	\$4,569	\$4,734	\$4,908
FTRB2-2460-4W	Wood	Uph	24	60	18	33	100	5	\$3,505	\$3,670	\$3,842	\$4,022	\$4,211	\$4,408	\$4,569	\$4,734	\$4,908
FTRB2-2460-4D	Duo	Uph	24	60	18	33	100	5	\$3,505	\$3,670	\$3,842	\$4,022	\$4,211	\$4,408	\$4,569	\$4,734	\$4,908

Halfback Rectangle Junior																	
FTRB2J-2436	Self-leveling Glide	Uph	24	36	16	31	55	3.25	\$3,457	\$3,563	\$3,635	\$3,737	\$3,835	\$3,934	\$4,075	\$4,224	\$4,378
FTRB2J-2448	Self-leveling Glide	Uph	24	48	16	31	75	4	\$3,457	\$3,563	\$3,635	\$3,737	\$3,835	\$3,934	\$4,075	\$4,224	\$4,378
FTRB2J-2460	Self-leveling Glide	Uph	24	60	16	31	100	5	\$3,505	\$3,670	\$3,842	\$4,022	\$4,211	\$4,408	\$4,569	\$4,734	\$4,908

Halfback Curve & Quarterback Crescent List Price

Halfback 60-degree Curve (Seating on Concave side)																	
Model Number	Base	Seat	Curve	Over-all Width	Seat Hgt.	Overall Height	Wgt. (lbs.)	COM Yd.	List Price								
									Grade 1 COM	Grade 2	Grade 3	Grade 4	Grade 5	Grade 6	Grade 7	Grade 8	Grade 9
FTCBV2-60-5S	Steel Post	Uph	60	54	18	33	160	5	\$4,206	\$4,474	\$4,782	\$5,069	\$5,372	\$5,691	\$5,900	\$6,113	\$6,335
FTCBV2-60-5C	Casters	Uph	60	54	18	33	160	5	\$4,206	\$4,474	\$4,782	\$5,069	\$5,372	\$5,691	\$5,900	\$6,113	\$6,335
FTCBV2-60-5W	Wood	Uph	60	54	18	33	160	5	\$4,206	\$4,474	\$4,782	\$5,069	\$5,372	\$5,691	\$5,900	\$6,113	\$6,335
FTCBV2-60-5WD	Duo	Uph	60	54	18	33	160	5	\$4,206	\$4,474	\$4,782	\$5,069	\$5,372	\$5,691	\$5,900	\$6,113	\$6,335
FTCBV2-60-7224-5S	Steel Post	Uph	60	72	18	33	180	5	\$4,417	\$4,698	\$5,022	\$5,323	\$5,635	\$5,977	\$6,195	\$6,419	\$6,655
FTCBV2-60-7224-5C	Casters	Uph	60	72	18	33	180	5	\$4,417	\$4,698	\$5,022	\$5,323	\$5,635	\$5,977	\$6,195	\$6,419	\$6,655
FTCBV2-60-7224-5W	Wood	Uph	60	72	18	33	180	5	\$4,417	\$4,698	\$5,022	\$5,323	\$5,635	\$5,977	\$6,195	\$6,419	\$6,655
FTCBV2-60-7224-5D	Duo	Uph	60	72	18	33	180	5	\$4,417	\$4,698	\$5,022	\$5,323	\$5,635	\$5,977	\$6,195	\$6,419	\$6,655

Halfback 60-degree Curve Junior Seating on Concave side																	
FTCBV2J-60	Self-leveling Glide	Uph	60	54	16	31	160	5	\$4,206	\$4,474	\$4,782	\$5,069	\$5,372	\$5,691	\$5,900	\$6,113	\$6,335
FTCBV2J-60-7224	Self-leveling Glide	Uph	60	72	16	31	180	5	\$4,417	\$4,698	\$5,022	\$5,323	\$5,635	\$5,977	\$6,195	\$6,419	\$6,655

Halfback 60-degree Curve (Seating on Convex side)																	
Model Number	Base	Seat	Curve	Over-all Width	Seat Hgt.	Overall Height	Wgt. (lbs.)	COM Yd.	List Price								
									Grade 1 COM	Grade 2	Grade 3	Grade 4	Grade 5	Grade 6	Grade 7	Grade 8	Grade 9
FTCBX2-60-5S	Steel Post	Uph	60	54	18	33	160	5	\$4,206	\$4,474	\$4,782	\$5,069	\$5,372	\$5,691	\$5,900	\$6,113	\$6,335
FTCBX2-60-5C	Casters	Uph	60	54	18	33	160	5	\$4,206	\$4,474	\$4,782	\$5,069	\$5,372	\$5,691	\$5,900	\$6,113	\$6,335
FTCBX2-60-5W	Wood	Uph	60	54	18	33	160	5	\$4,206	\$4,474	\$4,782	\$5,069	\$5,372	\$5,691	\$5,900	\$6,113	\$6,335
FTCBX2-60-5D	Duo	Uph	60	54	18	33	160	5	\$4,206	\$4,474	\$4,782	\$5,069	\$5,372	\$5,691	\$5,900	\$6,113	\$6,335
FTCBX2-60-7224-5S	Steel Post	Uph	60	72	18	33	180	5	\$4,417	\$4,698	\$5,022	\$5,323	\$5,635	\$5,977	\$6,195	\$6,419	\$6,655
FTCBX2-60-7224-5C	Casters	Uph	60	72	18	33	180	5	\$4,417	\$4,698	\$5,022	\$5,323	\$5,635	\$5,977	\$6,195	\$6,419	\$6,655
FTCBX2-60-7224-5W	Wood	Uph	60	72	18	33	180	5	\$4,417	\$4,698	\$5,022	\$5,323	\$5,635	\$5,977	\$6,195	\$6,419	\$6,655
FTCBX2-60-7224-5D	Duo	Uph	60	72	18	33	180	5	\$4,417	\$4,698	\$5,022	\$5,323	\$5,635	\$5,977	\$6,195	\$6,419	\$6,655

Halfback 60-degree Curve Junior (Seating on Convex side)																	
FTCBX2J-60	Self-leveling Glide	Uph	60	54	16	31	160	5	\$4,206	\$4,474	\$4,782	\$5,069	\$5,372	\$5,691	\$5,900	\$6,113	\$6,335
FTCBX2J-60-7224	Self-leveling Glide	Uph	60	72	16	31	180	5	\$4,417	\$4,698	\$5,022	\$5,323	\$5,635	\$5,977	\$6,195	\$6,419	\$6,655

Quarterback Crescent (Back on Left Side)																	
Model Number	Base	Seat & Back	Depth (in.)	Width (in.)	Seat Hgt. (in.)	Overall Height (in.)	Wgt. (lbs.)	COM Yd.	List Price								
									Grade 1 COM	Grade 2	Grade 3	Grade 4	Grade 5	Grade 6	Grade 7	Grade 8	Grade 9
FTCOQL-0036-5S	Steel post	Uph	30	36	18	33	78	3.5	\$2,238	\$2,372	\$2,585	\$2,720	\$2,950	\$3,148	\$3,217	\$3,282	\$3,422
FTCOQL-0036-5C	Casters	Uph	30	36	18	33	78	3.5	\$2,238	\$2,372	\$2,585	\$2,720	\$2,950	\$3,148	\$3,217	\$3,282	\$3,422
FTCOQL-0036-5W	Wood	Uph	30	36	18	33	78	3.5	\$2,238	\$2,372	\$2,585	\$2,720	\$2,950	\$3,148	\$3,217	\$3,282	\$3,422
FTCOQL-0036-5D	Duo	Uph	30	36	18	33	78	3.5	\$2,238	\$2,372	\$2,585	\$2,720	\$2,950	\$3,148	\$3,217	\$3,282	\$3,422

Quarterback Crescent Junior (Back on Left Side)																	
FTCOQLJ-0036	Self-leveling glide	Uph	30	36	16	31	78	3.5	\$2,238	\$2,372	\$2,585	\$2,720	\$2,950	\$3,148	\$3,217	\$3,282	\$3,422

P-TIMESERIES-240114



Ottobles List Price

Quarterback Crescent (Back on Right Side)																	
Model Number	Base	Seat & Back	Depth (in.)	Width (in.)	Seat Hgt. (in.)	Overall Height (in.)	Wgt. (lbs.)	COM Yd.	List Price								
									Grade 1 COM	Grade 2	Grade 3	Grade 4	Grade 5	Grade 6	Grade 7	Grade 8	Grade 9
FTCOQR-0036-5S	Steel post	Uph	30	36	18	33	78	3.5	\$2,238	\$2,372	\$2,585	\$2,720	\$2,950	\$3,148	\$3,217	\$3,282	\$3,422
FTCOQR-0036-5C	Casters	Uph	30	36	18	33	78	3.5	\$2,238	\$2,372	\$2,585	\$2,720	\$2,950	\$3,148	\$3,217	\$3,282	\$3,422
FTCOQR-0036-5W	Wood	Uph	30	36	18	33	78	3.5	\$2,238	\$2,372	\$2,585	\$2,720	\$2,950	\$3,148	\$3,217	\$3,282	\$3,422
FTCOQR-0036-5D	Duo	Uph	30	36	18	33	78	3.5	\$2,238	\$2,372	\$2,585	\$2,720	\$2,950	\$3,148	\$3,217	\$3,282	\$3,422
Quarterback Crescent Junior (Back on Right Side)																	
FTCOQRJ-0036	Self-leveling glide	Uph	30	36	16	31	78	3.5	\$2,238	\$2,372	\$2,585	\$2,720	\$2,950	\$3,148	\$3,217	\$3,282	\$3,422
Round Ottobles																	
Model Number	Legs	Base	Work-surface	Diameter (in.)	Height (in.)	Weight (in.)	COM (yds.)	List Price									
								Grade 1 COM	Grade 2	Grade 3	Grade 4	Grade 5	Grade 6	Grade 7	Grade 8	Grade 9	
FTDT-30-5S	Steel Post	Uph	HPL	30	18	118	3	\$1,807	\$1,964	\$2,103	\$2,244	\$2,385	\$2,525	\$2,674	\$2,833	\$3,004	
FTDT-30-5C	Casters	Uph	HPL	30	18	118	3	\$1,807	\$1,964	\$2,103	\$2,244	\$2,385	\$2,525	\$2,674	\$2,833	\$3,004	
FTDT-30-5W	Wood Post	Uph	HPL	30	18	118	3	\$1,807	\$1,964	\$2,103	\$2,244	\$2,385	\$2,525	\$2,674	\$2,833	\$3,004	
FTDT-30-5D	Duo	Uph	HPL	30	18	118	3	\$1,807	\$1,964	\$2,103	\$2,244	\$2,385	\$2,525	\$2,674	\$2,833	\$3,004	
FTDT-36-5S	Steel Post	Uph	HPL	36	18	127	3.25	\$1,899	\$2,064	\$2,209	\$2,357	\$2,508	\$2,653	\$2,811	\$2,977	\$3,154	
FTDT-36-5C	Casters	Uph	HPL	36	18	127	3.25	\$1,899	\$2,064	\$2,209	\$2,357	\$2,508	\$2,653	\$2,811	\$2,977	\$3,154	
FTDT-36-5W	Wood Post	Uph	HPL	36	18	127	3.25	\$1,899	\$2,064	\$2,209	\$2,357	\$2,508	\$2,653	\$2,811	\$2,977	\$3,154	
FTDT-36-5D	Duo	Uph	HPL	36	18	127	3.25	\$1,899	\$2,064	\$2,209	\$2,357	\$2,508	\$2,653	\$2,811	\$2,977	\$3,154	
FTDT-51-5S	Steel Post	Uph	HPL	51	18	195	3.5	\$2,773	\$2,954	\$3,112	\$3,270	\$3,425	\$3,583	\$3,746	\$3,918	\$4,098	
FTDT-51-5C	Casters	Uph	HPL	51	18	195	3.5	\$2,773	\$2,954	\$3,112	\$3,270	\$3,425	\$3,583	\$3,746	\$3,918	\$4,098	
FTDT-51-5W	Wood Post	Uph	HPL	51	18	195	3.5	\$2,773	\$2,954	\$3,112	\$3,270	\$3,425	\$3,583	\$3,746	\$3,918	\$4,098	
FTDT-51-5D	Duo	Uph	HPL	51	18	195	3.5	\$2,773	\$2,954	\$3,112	\$3,270	\$3,425	\$3,583	\$3,746	\$3,918	\$4,098	
Round Junior Ottobles																	
FTDTJ-30	Self-leveling Glides	Uph	HPL	30	16	118	3	\$1,807	\$1,964	\$2,103	\$2,244	\$2,385	\$2,525	\$2,674	\$2,833	\$3,004	
FTDTJ-36	Self-leveling Glides	Uph	HPL	36	16	127	3.25	\$1,899	\$2,064	\$2,209	\$2,357	\$2,508	\$2,653	\$2,811	\$2,977	\$3,154	
FTDTJ-51	Self-leveling Glides	Uph	HPL	51	16	195	3.5	\$2,773	\$2,954	\$3,112	\$3,270	\$3,425	\$3,583	\$3,746	\$3,918	\$4,098	
Square Ottobles																	
Model Number	Legs	Base	Work-surface	Depth (in.)	Width (in.)	Height (in.)	Weight (in.)	COM (yds.)	List Price								
									Grade 1 COM	Grade 2	Grade 3	Grade 4	Grade 5	Grade 6	Grade 7	Grade 8	Grade 9
FTST-2424-4S	Steel Post	Uph	HPL	24	24	18	78	1.75	\$1,600	\$1,655	\$1,717	\$1,779	\$1,844	\$1,910	\$1,982	\$2,053	\$2,132
FTST-2424-4C	Casters	Uph	HPL	24	24	18	78	1.75	\$1,600	\$1,655	\$1,717	\$1,779	\$1,844	\$1,910	\$1,982	\$2,053	\$2,132
FTST-2424-4W	Wood Post	Uph	HPL	24	24	18	78	1.75	\$1,600	\$1,655	\$1,717	\$1,779	\$1,844	\$1,910	\$1,982	\$2,053	\$2,132
FTST-2424-4D	Duo	Uph	HPL	24	24	18	78	1.75	\$1,600	\$1,655	\$1,717	\$1,779	\$1,844	\$1,910	\$1,982	\$2,053	\$2,132
FTST-3636-4S	Steel Post	Uph	HPL	36	36	18	129	2.25	\$1,730	\$1,844	\$1,945	\$2,047	\$2,146	\$2,249	\$2,355	\$2,469	\$2,587
FTST-3636-4C	Casters	Uph	HPL	36	36	18	129	2.25	\$1,730	\$1,844	\$1,945	\$2,047	\$2,146	\$2,249	\$2,355	\$2,469	\$2,587
FTST-3636-4W	Wood Post	Uph	HPL	36	36	18	129	2.25	\$1,730	\$1,844	\$1,945	\$2,047	\$2,146	\$2,249	\$2,355	\$2,469	\$2,587
FTST-3636-4D	Duo	Uph	HPL	36	36	18	129	2.25	\$1,730	\$1,844	\$1,945	\$2,047	\$2,146	\$2,249	\$2,355	\$2,469	\$2,587
FTST-4040-4S	Steel Post	Uph	HPL	40	40	18	145	2.5	\$1,903	\$2,028	\$2,139	\$2,251	\$2,360	\$2,474	\$2,591	\$2,716	\$2,846
FTST-4040-4C	Casters	Uph	HPL	40	40	18	145	2.5	\$1,903	\$2,028	\$2,139	\$2,251	\$2,360	\$2,474	\$2,591	\$2,716	\$2,846
FTST-4040-4W	Wood Post	Uph	HPL	40	40	18	145	2.5	\$1,903	\$2,028	\$2,139	\$2,251	\$2,360	\$2,474	\$2,591	\$2,716	\$2,846
FTST-4040-4D	Duo	Uph	HPL	40	40	18	145	2.5	\$1,903	\$2,028	\$2,139	\$2,251	\$2,360	\$2,474	\$2,591	\$2,716	\$2,846

P-TIMESERIES-240114

Ottables List Price

Square Junior Ottables																	
FTSTJ-2424	Self-leveling Glides	Uph	HPL	24	24	16	78	1.75	\$1,600	\$1,655	\$1,717	\$1,779	\$1,844	\$1,910	\$1,982	\$2,053	\$2,132
FTSTJ-3636	Self-leveling Glides	Uph	HPL	36	36	16	129	2.25	\$1,730	\$1,844	\$1,945	\$2,047	\$2,146	\$2,249	\$2,355	\$2,469	\$2,587
FTSTJ-4040	Self-leveling Glides	Uph	HPL	40	40	16	145	2.5	\$1,903	\$2,028	\$2,139	\$2,251	\$2,360	\$2,474	\$2,591	\$2,716	\$2,846

Rectangle Ottables																	
Model Number	Legs	Base	Work-surface	Depth (in.)	Width (in.)	Height (in.)	Weight (in.)	COM (yds.)	List Price								
									Grade 1 COM	Grade 2	Grade 3	Grade 4	Grade 5	Grade 6	Grade 7	Grade 8	Grade 9
FTRT-1824-4S	Steel Post	Uph	HPL	18	24	18	66	1.3	\$1,253	\$1,308	\$1,364	\$1,433	\$1,504	\$1,572	\$1,648	\$1,725	\$1,808
FTRT-1824-4C	Casters	Uph	HPL	18	24	18	66	1.3	\$1,253	\$1,308	\$1,364	\$1,433	\$1,504	\$1,572	\$1,648	\$1,725	\$1,808
FTRT-1824-4W	Wood Post	Uph	HPL	18	24	18	66	1.3	\$1,253	\$1,308	\$1,364	\$1,433	\$1,504	\$1,572	\$1,648	\$1,725	\$1,808
FTRT-1824-4D	Duo	Uph	HPL	18	24	18	66	1.3	\$1,253	\$1,308	\$1,364	\$1,433	\$1,504	\$1,572	\$1,648	\$1,725	\$1,808
FTRT-1836-4S	Steel Post	Uph	HPL	18	36	18	75	1.75	\$1,415	\$1,470	\$1,532	\$1,610	\$1,689	\$1,767	\$1,851	\$1,937	\$2,007
FTRT-1836-4C	Casters	Uph	HPL	18	36	18	75	1.75	\$1,415	\$1,470	\$1,532	\$1,610	\$1,689	\$1,767	\$1,851	\$1,937	\$2,007
FTRT-1836-4W	Wood Post	Uph	HPL	18	36	18	75	1.75	\$1,415	\$1,470	\$1,532	\$1,610	\$1,689	\$1,767	\$1,851	\$1,937	\$2,007
FTRT-1836-4D	Duo	Uph	HPL	18	36	18	75	1.75	\$1,415	\$1,470	\$1,532	\$1,610	\$1,689	\$1,767	\$1,851	\$1,937	\$2,007
FTRT-2436-4S	Steel Post	Uph	HPL	24	36	18	99	1.75	\$1,450	\$1,510	\$1,588	\$1,670	\$1,774	\$1,829	\$1,885	\$1,946	\$2,031
FTRT-2436-4C	Casters	Uph	HPL	24	36	18	99	1.75	\$1,450	\$1,510	\$1,588	\$1,670	\$1,774	\$1,829	\$1,885	\$1,946	\$2,031
FTRT-2436-4W	Wood Post	Uph	HPL	24	36	18	99	1.75	\$1,450	\$1,510	\$1,588	\$1,670	\$1,774	\$1,829	\$1,885	\$1,946	\$2,031
FTRT-2436-4D	Duo	Uph	HPL	24	36	18	99	1.75	\$1,450	\$1,510	\$1,588	\$1,670	\$1,774	\$1,829	\$1,885	\$1,946	\$2,031
FTRT-2448-4S	Steel Post	Uph	HPL	24	48	18	116	2	\$1,789	\$1,853	\$1,916	\$1,987	\$2,056	\$2,133	\$2,210	\$2,294	\$2,384
FTRT-2448-4C	Casters	Uph	HPL	24	48	18	116	2	\$1,789	\$1,853	\$1,916	\$1,987	\$2,056	\$2,133	\$2,210	\$2,294	\$2,384
FTRT-2448-4W	Wood Post	Uph	HPL	24	48	18	116	2	\$1,789	\$1,853	\$1,916	\$1,987	\$2,056	\$2,133	\$2,210	\$2,294	\$2,384
FTRT-2448-4D	Duo	Uph	HPL	24	48	18	116	2	\$1,789	\$1,853	\$1,916	\$1,987	\$2,056	\$2,133	\$2,210	\$2,294	\$2,384

Rectangle Junior Ottables																	
FTRTJ-1824	Self-leveling Glides	Uph	HPL	18	24	16	66	1.3	\$1,253	\$1,308	\$1,364	\$1,433	\$1,504	\$1,572	\$1,648	\$1,725	\$1,808
FTRTJ-1836	Self-leveling Glides	Uph	HPL	18	36	16	75	1.75	\$1,415	\$1,470	\$1,532	\$1,610	\$1,689	\$1,767	\$1,851	\$1,937	\$2,031
FTRTJ-2436	Self-leveling Glides	Uph	HPL	24	36	16	99	1.75	\$1,450	\$1,510	\$1,588	\$1,670	\$1,774	\$1,829	\$1,885	\$1,946	\$2,007
FTRTJ-2448	Self-leveling Glides	Uph	HPL	24	48	16	116	2	\$1,789	\$1,853	\$1,916	\$1,987	\$2,056	\$2,133	\$2,210	\$2,294	\$2,384

Set Up Charges and Upcharges for Non-Standard and Custom Finishes		
Model Number	Description	List Price
Group 2 Powder Coat	Set up charge, per color, per order, for Group 2 Powder Coat	\$329
Non-Standard PVC	Upcharge, per color, per order, for non-standard PVC	\$911